

PENTAX

VHS VIDEO DECK

MODEL PV-T150A

INSTRUCTION MANUAL

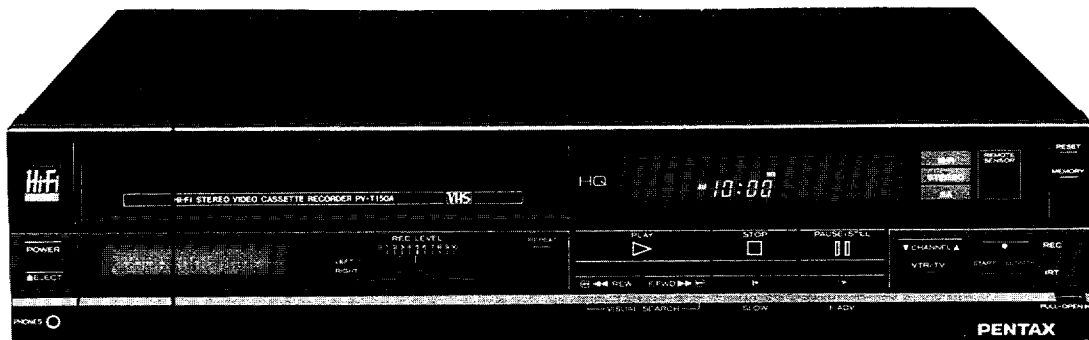

CONGRATULATIONS

You are now the proud owner of a Pentax VTR. Please read this instruction manual carefully before use and refer to it if any difficulties arise.

FEATURES

- Auto programming with frequency synthesizer tuner
- Hi-Fi VHS recording (see page 4)
- Setting 4 programs/2 week is possible with built-in programmable timer
- Tuning ability for cable systems channel A-1, A-2, A ~ W and W+1 ~ W+12
- Infrared remote control operation
- Multichannel Television Sound (MTS) is receivable
- Instant recording timer
- Maximum 8 hours recording/playback
- Front loading mechanism
- Automatic rewind
- Soft touch control with microprocessor
- Visual search
- Rewind shut-off
- Automatic power on

HQ This Video Tape Recorder (VTR) with this marking incorporates **VHS** high-quality picture technology and is compatible with any VTR bearing the **VHS** mark.

CONTENTS

FOR YOUR SAFETY	3
Hi-Fi VHS	4
CONTROLS AND FEATURES	5
INSTALLATION	8
CHANNEL TUNING	15
VIDEO CHANNEL SETTING	16
CLOCK TIME SETTING	17
NORMAL TV VIEWING	17
CASSETTE TAPES	18
RECORDING TV PROGRAMS	18
INSTANT RECORDING	20
PLAYBACK	21
TIMER RECORDING	22
REMOTE OPERATION	24
RECORDING AND PLAYBACK OF SIMULCASTS	26
RECORDING FROM A VIDEO CAMERA	28
HEAD CLEANING	28
PERIODIC MAINTENANCE	29
PROBLEM GUIDE	29
SPECIFICATIONS	30

FOR YOUR SAFETY

Power supply: AC 120V, 60 Hz only

The POWER switch located on the front panel of the VTR switches the VTR on and off, leaving the clock/timer unaffected.

If the unit is to be left unattended for a long period and it is not intended to use the timer recording function, it is recommended that the unit be completely switched off and the plug removed. If you intend to record during your absence, remember there is no necessity for the TV receiver to be switched on.

Illustrated below is the label on the back of your unit.



The lightning flash with arrowhead symbol, within an equilateral triangle, is intended to alert the user to the presence of uninsulated "dangerous voltage" within the product's enclosure that may be of sufficient magnitude to constitute a risk of electric shock to persons.

The exclamation point within an equilateral triangle is intended to alert the user of the presence of important operating and maintenance (servicing) instructions in the literature accompanying the appliance.

**CAUTION: TO REDUCE THE RISK OF ELECTRIC SHOCK,
DO NOT REMOVE COVER (OR BACK).
NO USER-SERVICEABLE PARTS INSIDE.
REFER SERVICING TO QUALIFIED SERVICE PERSONNEL.**

WARNING:

Many television programs are copyrighted. One court has held that private, non-commercial, in-home video taping of copyrighted televised programs constitutes copyright infringement. Purchasers are advised not to copy such programs.

WARNING: TO PREVENT FIRE OR ELECTRIC SHOCK, DO NOT EXPOSE THIS APPLIANCE TO RAIN OR MOISTURE.

Moisture condensation

If you pour cold liquid into a glass, water vapor in the air will condense on the surface of the glass. This is moisture condensation.

Moisture condensation on the head drum, one of the most crucial parts of the unit, will cause damage to the tape. When the VTR is exposed to a rapid temperature change from cold to warm, some condensation will occur. The presence of internal moisture will cause the pause indicator (□□) to flash and the VTR will not operate. If this condition occurs, turn the power off and allow at least 2 hours for the unit to dry out. When the pause indicator (□□) no longer flashes, the VTR can be operated.

Caution for users living in an area with frequent electrical storms

Your VTR and TV may be damaged during electrical storms if they are connected to a cable system, outside antenna, or they are plugged into the AC outlet. Proper lightning arresters on the antenna and the use of surge protection devices between the VTR plug and AC outlet, and TV and AC outlet will decrease the likelihood of damage from lightning surges in the power line or antenna system. During storms, the VTR and TV should be unplugged from the AC outlet, and the cable or antenna should be disconnected if possible.

Power line surge protection devices often cease to operate when they have handled an overload. When they are external to the unit and become inoperative, they can be replaced without the aid of a technician. Power line surge protection devices are available through electronic stores or computer dealers.

You may also wish to check with your insurance agent about insurance protection for electrical storm damage to this and other electronic appliances in your home.

Hi-Fi VHS

Hi-Fi VHS video recorders record sound using two systems simultaneously.

One system records the linear audio track as with conventional recorders and the other records an FM (frequency modulated) audio signal together with the video track.

1. Differences between conventional and Hi-Fi VHS recorders

• Conventional recorder

The audio signal is recorded on the linear audio track and the video signal is recorded on the video track.

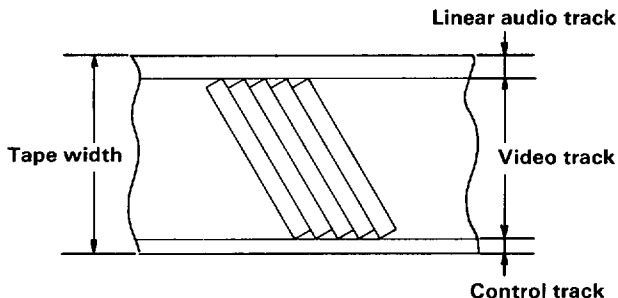

• Hi-Fi recorder

Audio signals are recorded on the video track together with the video signal as well as on the linear audio track. The audio signals recorded on the video track are frequency modulated.

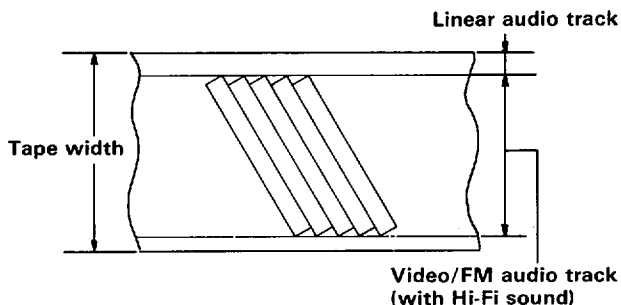

2. Advantages of Hi-Fi VHS recorders

As the sound is recorded after frequency modulation, it has the following advantages.

- Excellent frequency response
- Less noise and distortion
- Wide dynamic range

In addition to these advantages since the two rotary heads are used to record and play back the audio signals, the relative speed of the tape and heads is 520 times the relative speed of the tape and head in the linear audio track in the EP mode so that wow and flutter is below the measurable limit.

3. Compatibility of tapes recorded by this recorder and tapes recorded by recorders not equipped to record Hi-Fi sound

Because the audio signal is recorded on the linear audio track together with the Hi-Fi signal, tapes recorded by this recorder can be played back on conventional recorders and tapes recorded by other recorders without Hi-Fi can be played by this recorder.

4. Recording broadcast stereo TV

(See page 19 for operations)

- Separate left and right channel audio signals are recorded on the Hi-Fi audio track so that stereo broadcasts can be recorded in stereo.
- Stereo broadcasts are also recorded as monaural on the linear audio track.

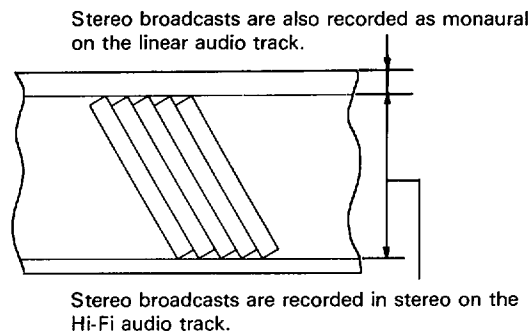

- AUTO/LINEAR SELECT SWITCH (behind secondary controls door)

AUTO LINEAR



This selects between Hi-Fi and linear audio in playback. Normally set to "AUTO".

When a tape recorded on both Hi-Fi and linear audio tracks (for example, the tapes recorded with your VTR) is played back, Hi-Fi audio is automatically played back; when a tape without Hi-Fi audio is played back (for example, the tapes recorded with the VTR that is not provided with Hi-Fi VHS), linear audio is automatically played back.

When the switch is set to the "LINEAR" position, only the linear audio is played, even if the tape was recorded with Hi-Fi audio tracks.

Notes:

1. When the sound becomes unstable during Hi-Fi playback, the sound is muted temporarily. If the sound deteriorates even more, it switches over and plays back linear audio.
2. As rotary heads are used to pick up the Hi-Fi audio track, the heads and tape transport system are more likely to become dirty due to dust and magnetic particles from the tape when compared with an audio cassette recorder or reel-to-reel deck. When the heads get dirty, the Hi-Fi sound may not be heard or may be interrupted. If this happens, consult your dealer.

CONTROLS AND FEATURES

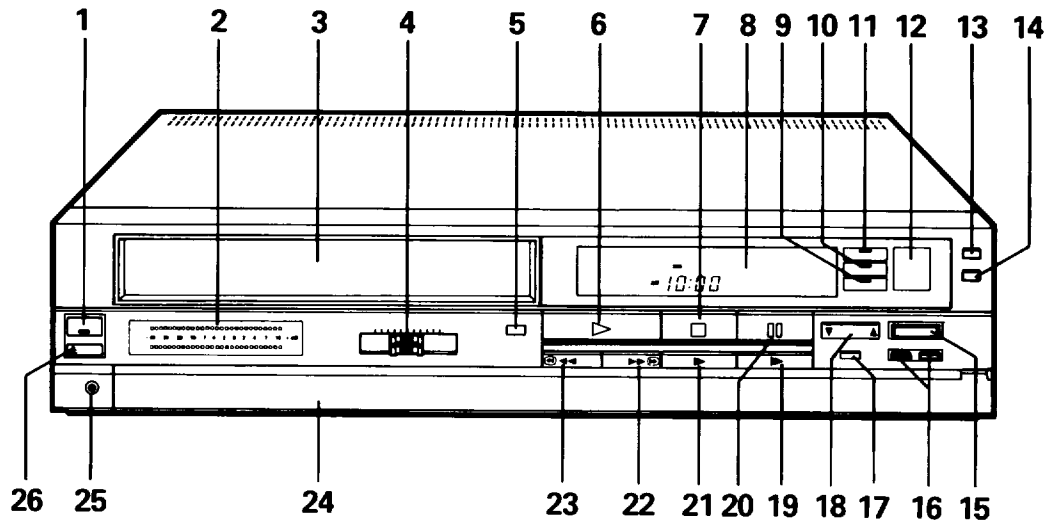

1. POWER SWITCH

Turn system power on and off.

2. REC LEVEL METER

Shows the peak input level of each audio channel during recording and the recorded levels during playback.

3. CASSETTE COMPARTMENT

4. RECORDING LEVEL CONTROLS

When recording with the METER & ALC switch set to "ALC OFF", adjust these controls so that 6 red segments light occasionally (during especially loud portions).

5. REPEAT BUTTON

Press this button after pressing the PLAY button to repeat the scene you have just viewed during playback. The tape is rewound to the position where PLAY button was pressed, then the tape is played back from that position.

6. PLAY BUTTON

Press to start play.

7. STOP BUTTON

Press to stop tape. The STOP button must be pressed between "RECORD" and any other operation.

8. ELECTRONIC DIGITAL DISPLAY

See next page for details.

9. SA (Second Audio Program) INDICATOR

Some TV stations transmit a "Second Audio Program" (SA). The SA is normally used for a second language. This indicator lights when the VTR is tuned to SA broadcast.

10. STEREO INDICATOR

Lights when receiving a stereo broadcast.

11. HI-FI INDICATOR

Lights when playing back tapes recorded with Hi-Fi VHS sound.

12. INFRARED RAY RECEIVING SECTION

Receives the infrared ray from remote control unit.

13. COUNTER RESET BUTTON

To reset counter to "0000".

14. MEMORY BUTTON

If this button is pressed, "M" appears on the display and it memorizes the tape position of "0000".

15. RECORD BUTTON

Press to start recording.

16. INSTANT RECORDING TIMER BUTTONS (IRT)

IRT allows unattended recording without programming the timer. See page 20 for details.

17. VTR/TV SELECT SWITCH

Selects the signal to be viewed. The VTR indicator comes on when the unit is in VTR mode and the signal received by the VTR is displayed on the TV screen. With the switch in the TV position (indicator light off) the broadcast signal is received directly by your TV set. When the VTR power is turned off, the VTR automatically switches to "TV".

18. CHANNEL SELECT BUTTON

Select the channels you wish to view or to record by pressing this button.

And you can also select "AUX"* by pressing this button to record or watch the program input at the VIDEO IN and AUDIO IN.

(*One channel position either higher or lower outside the range of your preset channels.)

19. FRAME ADVANCE BUTTON

Press to view tape one frame at a time. Hold down button to advance frames continuously.

Operates only after PAUSE/STILL button has been pressed.

20. PAUSE/STILL BUTTON

Press to pause during recording or playback.

21. SLOW BUTTON

Allows you to view a picture at slow speed.

22. FAST FORWARD/VISUAL SEARCH BUTTON

Press to activate fast forward.

Press this button during playback of a recorded tape, and forward playback picture at high speed can be seen.

Digital Display

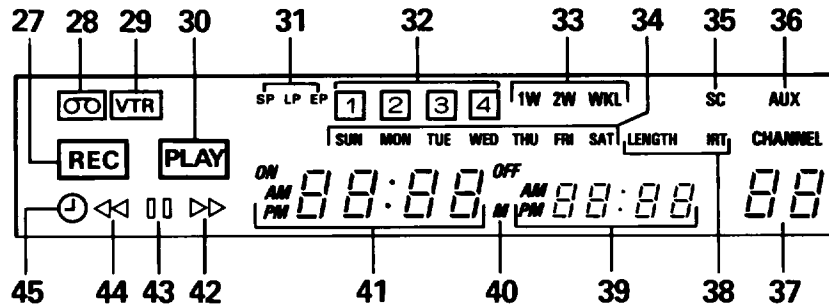

Controls behind the Door

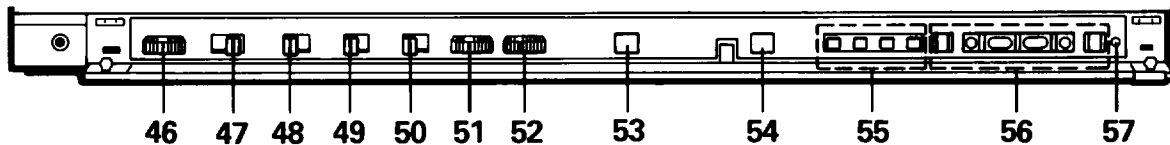

23. REWIND/VISUAL SEARCH BUTTON

Press to start rewind.
Press this button during playback of a recorded tape, and reverse playback picture at high speed can be seen.

24. DOOR FOR SECONDARY CONTROLS

25. PHONES SOCKET

Plug in a stereo headphone for private listening.

26. EJECT BUTTON

With power on, press to remove cassette.

27. **REC** INDICATOR

Appears during the record mode.

28. TAPE-IN INDICATOR

Lights when cassette is located in the compartment.

29. **VTR** INDICATOR

Appears when the VTR is turned on or the VTR is in the playback mode.

30. **PLAY** INDICATOR

Appears during the play mode.

31. TAPE SPEED INDICATORS

32. PROGRAM DESIGNATION FOR TIMER RECORDING

33. WEEK INDICATORS FOR TIMER RECORDING

1W: Up to seven days from the present day.
2W: Eighth day to fourteenth day from the present day.
WKL: Same day of each week.

34. DAY INDICATORS

Normally shows the current day of week. Shows the recording start day when programming the timer.

35. **SC (SIMULCAST)** INDICATOR

Lights when the SC button is turned on.

36. **AUX** INDICATOR

Will light when the AUX position is selected by pressing the CHANNEL select buttons. AUX position is used to record or watch the program input at the VIDEO IN and AUDIO IN.

37. CHANNEL INDICATOR

38. IRT INDICATOR

Lights during instant recording.

39. TAPE COUNTER DISPLAY

Normally shows tape counter. Shows time remaining during Instant recording and stop time for timer recording.

40. MEMORY INDICATOR

Appears when the MEMORY button is pressed. Rewind the tape with indication "M" lit, and the tape stops when the counter reads "0000".

41. CLOCK DISPLAY

Normally shows the clock (AM/PM).

42. **▷▷** INDICATOR

Appears during the fast-forward mode and it flashes during forward search mode.

43. **□□** INDICATOR

Appears when the PAUSE/STILL button is pressed during record and/or play mode and it disappears when the PAUSE/STILL button is pressed again. It flashes to indicate condensation on the VTR mechanism. The VTR will not operate until this indicator stop flashing. A cassette tape already in the VTR may be ejected.

44. **◀◀** INDICATOR

Appears during the rewind mode and it flashes during rewind search mode.

45. TIMER INDICATOR

Will light when turning power off after programming.

46. PHONES LEVEL CONTROL

Turn this control to change the headphones volume.

47. METER & ALC SELECT SWITCH

This switch has two functions.

- It works as the level meter ON/OFF switch. When the switch is set to "METER ON", the level meter lights. When it is set to "METER OFF", the meter switches off.
- It works as an "ALC" (Automatic Level Control) switch. When you set it to the "ALC ON" position, the recording level is controlled automatically. When you set it to the "ALC OFF" position, the audio recording level must be adjusted manually.

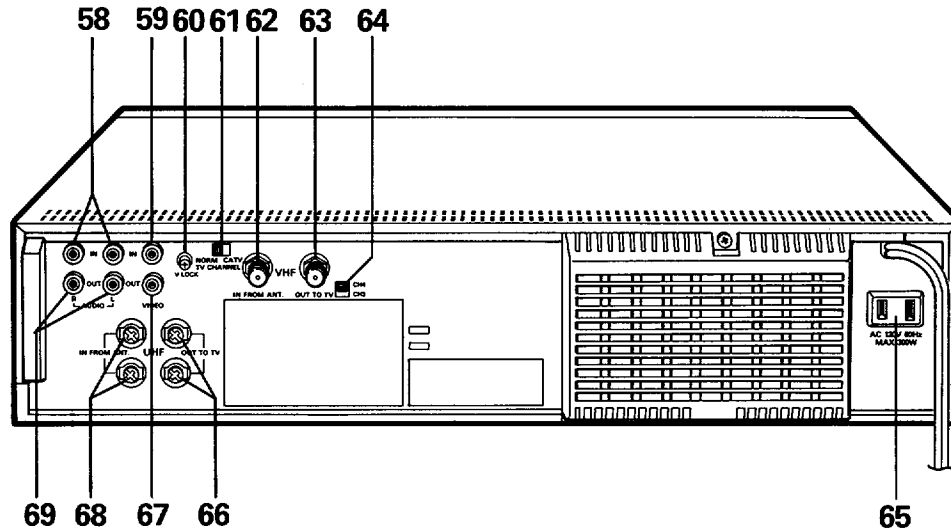

48. AUTO/LINEAR SELECT SWITCH

Selects the linear audio track playback or automatic selection of Hi-Fi VHS sound recorded on the tape. Normally set it to AUTO position.
Note: When Hi-Fi VHS sound is played back, Hi-Fi indicator lights up.

49. STEREO SWITCH

When a stereo broadcast is received (STEREO indicator lights) but the stereo signal is noisy (from a weak signal station, for example), set this switch to the OFF position. The audio you receive will be monaural. Monaural reception may be better than a noisy stereo signal. Normally set this switch to ON.

50. SA (Second Audio Program) SWITCH

Set this switch to "ON" to record or listen to the SA (Second Audio Program) broadcast. Normally set this switch to OFF.

51. TRACKING CONTROL KNOB

To minimize noise in playback.

52. SLOW TRACKING CONTROL KNOB

First press SLOW button during playback, then adjust this Control to minimize noise bands that may appear when using "SLOW", "STILL" or "FRAME ADVANCE" features. You will be able to move the noise band to either the top or bottom of the picture.

53. SC (SIMULCAST) BUTTON

Allows you to record audio signals from AUDIO IN jacks and video signal from built-in tuner. See page 26 for operation.

54. TAPE SPEED SELECT SWITCH

Recording time using Cassette tape T-160:
 EP: 8 hours
 LP: 5.3 hours
 SP: 2.6 hours

Note: Playback speed automatically corresponds with recorded speed.

55. CHANNEL PROGRAMMING CONTROLS

Program channels for channel up and down selection with these controls.

56. TIMER CONTROLS

57. DISPLAY RESET SWITCH

If the indication of the display appears abnormal, press this switch.

58. AUDIO IN

Receive audio signals from a stereo system or another VTR.

59. VIDEO IN

Receives video signal from a video camera or another VTR.

60. V. LOCK

Use to minimize vertical jitter during still playback.

61. NORM/CATV SELECTOR

Set to NORM for viewing or recording VHF channels 2 ~ 13 and UHF channels 14 ~ 83. Set to CATV for viewing or recording CATV channels 2 ~ 13, A ~ W, W+1 ~ W+12 and A-2, A-1.

62. VHF ANTENNA INPUT

Connect the VHF antenna to this terminal.

63. VHF ANTENNA OUTPUT

Connect this terminal to the VHF antenna terminal on the back of the TV.

64. RF CONVERTER SWITCH

Set this switch to whichever channel (CH3 or CH4) is unused in your area.

65. UNSWITCHED AC OUTLET

Power is available whenever the VTR is plugged in. Maximum load is 300 watts.

66. UHF ANTENNA OUTPUT

Connect these terminals to the UHF antenna terminals on the back of the TV.

67. VIDEO OUT

For connection to monitor TV.

68. UHF ANTENNA INPUT

Connect the UHF antenna to these terminals.

69. AUDIO OUT

For a connection to a monitor or another VTR.

INSTALLATION

INTRODUCTION

Place your Video Tape Recorder (VTR) in a horizontal position on a solid, stable surface near your TV. Connect the VTR AC plug into a non-switched AC outlet. Before you can use your VTR, the TV antenna connection must be moved to the VTR. Then new connections must be added from the VTR to the TV. Several accessories for common connections are included with your VTR. If your installation requires other accessories, they may be purchased at your Dealer or Electronic Parts Stores. There are several installations shown in the following figures. Select the figure which best matches your TV signal source, equipment features, and operating needs. TV broadcasts in your area may be VHF, UHF, or both. In a UHF-only area, use figure A2 for VHF and UHF connections between the VTR and TV. The VHF connection from VTR to TV is always needed for the VTR output channel of VHF Channel 3 or 4. Even if your VTR has Cable Tuning Ability (CTA), cable channels can only be received by connection to a Cable Service.

CABLE SYSTEMS

Cable system features and services vary in each local area. If you presently use your TV with a cable system, please read CABLE SYSTEMS INFORMATION on page 10 before making any connections.

Note to CATV system installers: This retailer is provided to all the CATV system installers a reference to Article 620-12 of the NEC which provides the standards for proper grounding and bonding. It requires that the cable ground shall be connected to the grounding system of the building as close to the point of cable entry as practical.

Rabbit ear antenna

Your VTR can be used with this type of antenna only if the picture is very clear and stable. When the antenna is part of the TV, the leads may not reach the VTR. You can either extend the leads, or obtain a movable rabbit ear antenna. We recommend using an outside antenna.

INTRODUCTION & ANTENNA SYSTEM

Precautions

- Use the VTR in a horizontal position ONLY.
- Allow air circulation space around, above, and below the VTR.
- Avoid extreme heat, cold, moisture, dust, magnetic fields, and strong vibrations.
- Keep everything, except air circulation and the video tape, from entering the VTR. An object or liquid (coin, paper clip, staple, flower pot soil, tobacco, ash, melted candle wax, drink or other items can cause damage to the VTR. If something gets into the VTR, immediately unplug the VTR and have it cleaned and inspected.
- Protect the VTR from household pets.
- Avoid cabinet finish damage from volatile agents in sprays, nail polish remover, alcohol, strong solvent cleaner, and chemically treaded cleaning cloths.
- In areas with frequent electrical storms, lightning protection devices attached to the cable/antenna should be checked each year for good connections and condition. AC power line Surge Protection accessories are recommended for the VTR and TV. Such devices are commonly used for computer protection, and will minimize damage to the TV and VTR in the event of AC surge from lightning strike or other cause. Whenever possible, the TV and VTR should be unplugged from AC, and disconnected from the antenna/cable during electrical storms.

ACCESSORIES PROVIDED WITH VTR

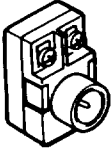
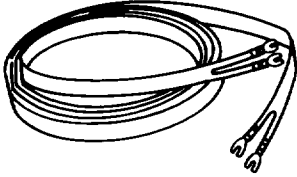
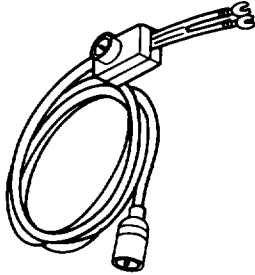
		
<p>VHF ANTENNA ADAPTOR</p>	<p>300-OHM FLAT LEAD TWIN CABLE</p>	<p>COAXIAL CABLE W/ADAPTOR</p>

VHF RECEPTION AREA – FIG. A1

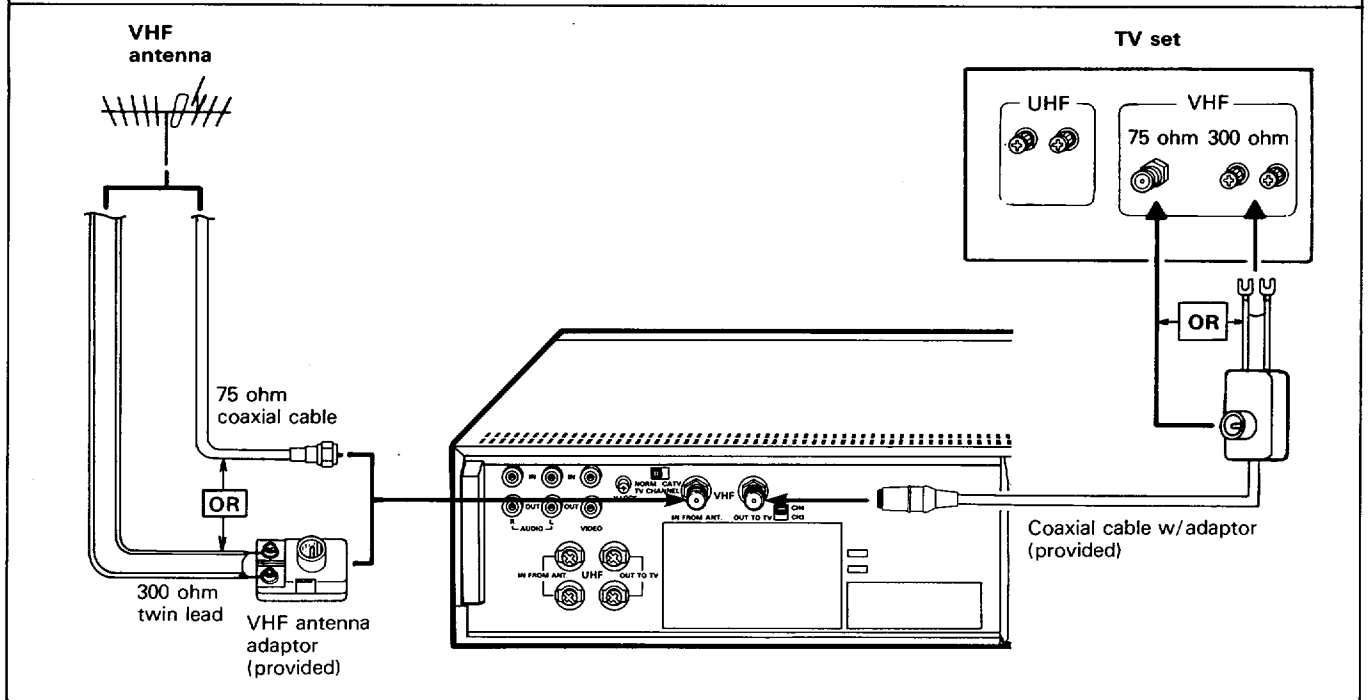

BOTH VHF AND UHF RECEPTION AREA (An antenna for each OR a combination antenna) – FIG. A2

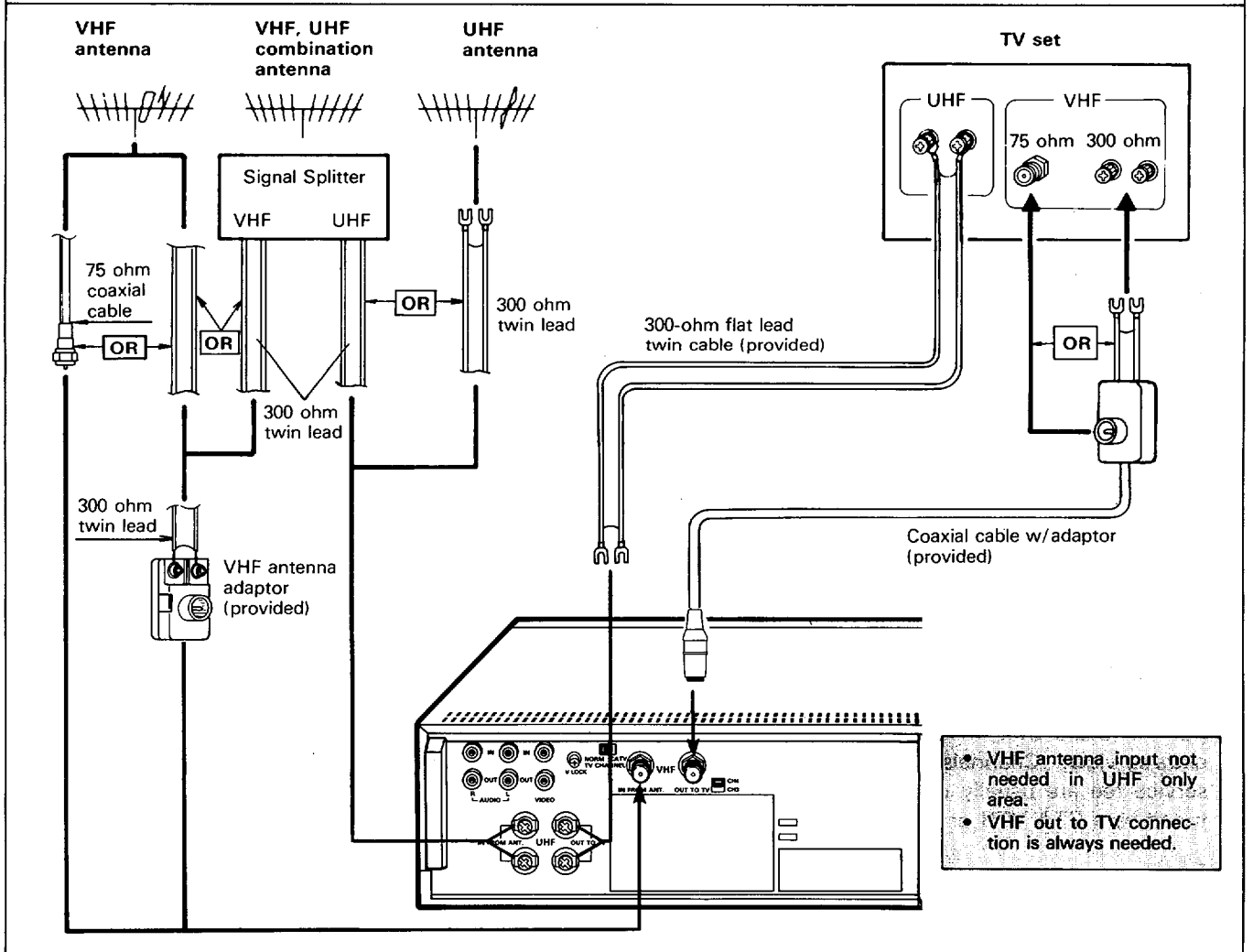

CABLE SYSTEM INFORMATION

Cable systems vary in features and services. The information and figures which follow cover most installations. If you need information about other installations, please write to Service at the nearest Pentax address listed at the back of this manual. The tuning abilities of your VTR and the type of cable service you have will determine what connections can be used. The VTR Tuning Range is listed in the rear of this Manual. VTRs with Cable Tuning Ability (CTA) are able to tune channels listed for CATV. Most cable services will be one of the following four types.

1. **Basic Cable:** Apartment buildings and planned communities may provide this type of service. No channel selection Cable Box is used with the TV. All channels are received using VHF channels 2 – 13. With this system, no special connections or operating procedures are needed. Connect the VTR and TV as shown in figure C1.
2. **Extended Cable – A Cable Box is used for TV Channel Selection:** The TV is usually set to channel 3 or 4, and all channel selection is performed using the cable company supplied Cable Box. In this type of system, no extra cost channels are available, and no channels are scrambled.
A CTA VTR can select channels on this system without a Cable Box, if the channels on the cable are in the VTR tuning range. The Cable Box may still be needed for the TV, unless the VTR is used as a cable converter. You can use figure C1, C2, or C3 for Extended Cable connection. Connections in C1 and C2 need no additional accessories. The connection of figure C3 allows recording and watching different programs but operation is more complicated.
3. **Extended Cable With Extra Cost Channels – No Scrambled Channels On System-Cable Converter Box Used For TV:** In this type of cable system, extra cost channels are added or deleted before the cable enters the customer home.
If a CTA VTR and CTA TV are used, a Cable Box is not needed. Connections can be made as shown in figure C1. If a non-CTA TV is used with a CTA VTR, either figure C2 or C3 can be used. If both non-CTA VTR and TV are used, figure C2 must be used.
4. **Extended Cable With Extra Cost Channels – Scrambled Channels on System-Cable Descrambler/Converter Box Used For TV:** In this type of system the cable company supplied Box must always be used to get proper reception of Extra Cost channels. All Extra Cost channels on the cable are scrambled, but the Cable Box unscrambles any that you pay extra to view. Channels included in the basic cable service fee are usually not scrambled, and can be tuned by a CTA VTR or CTA TV.

ADDITIONAL INFORMATION

When any type of scrambling is used for Extra Cost channels, the Cable Box must be used to view or record those channels. A CTA VTR does not include unscrambling ability. That ability is restricted to only cable company supplied equipment. On cable systems with scrambled channels, you have several choices. Among them are:

- a. Recording and watching only channels selected by the Cable Box (see figure C2).
- b. Adding a second cable company supplied Box.
- c. Adding switches to allow either recording and watching the channel selected by the Cable Box or recording a channel which is non-scrambled while watching another channel selected by the Cable Box (see figure C3).

Two Cable Systems: In some areas, two cables are used as inputs to the Cable Box. One cable may contain mostly non-scrambled channels, the other mostly Extra Cost scrambled channels. When you have a two-cable system, the cable with non-scrambled channels you wish to record (Cable A or Cable B) can usually be connected as in figure C3. One Cable can be connected directly, or both cables can be accessed by using the Cable Box. If you need to use both cables directly, write Pentax service for a connection diagram.

CAUTION: Only high quality, low loss switches and splitters should be used. All connections must be with shielded Coax cable. If your added connections degrade the performance of Extra Cost channels, all connections should be removed. The circuit of figure C2 should cause least signal loss. If even the circuit of figure C2 is not satisfactory, consult your cable company about installation.

CABLE SYSTEM VTR OPERATION

Direct Cable Connection

When a direct cable connection is used as in figure C1, VTR operation requires no special procedures.

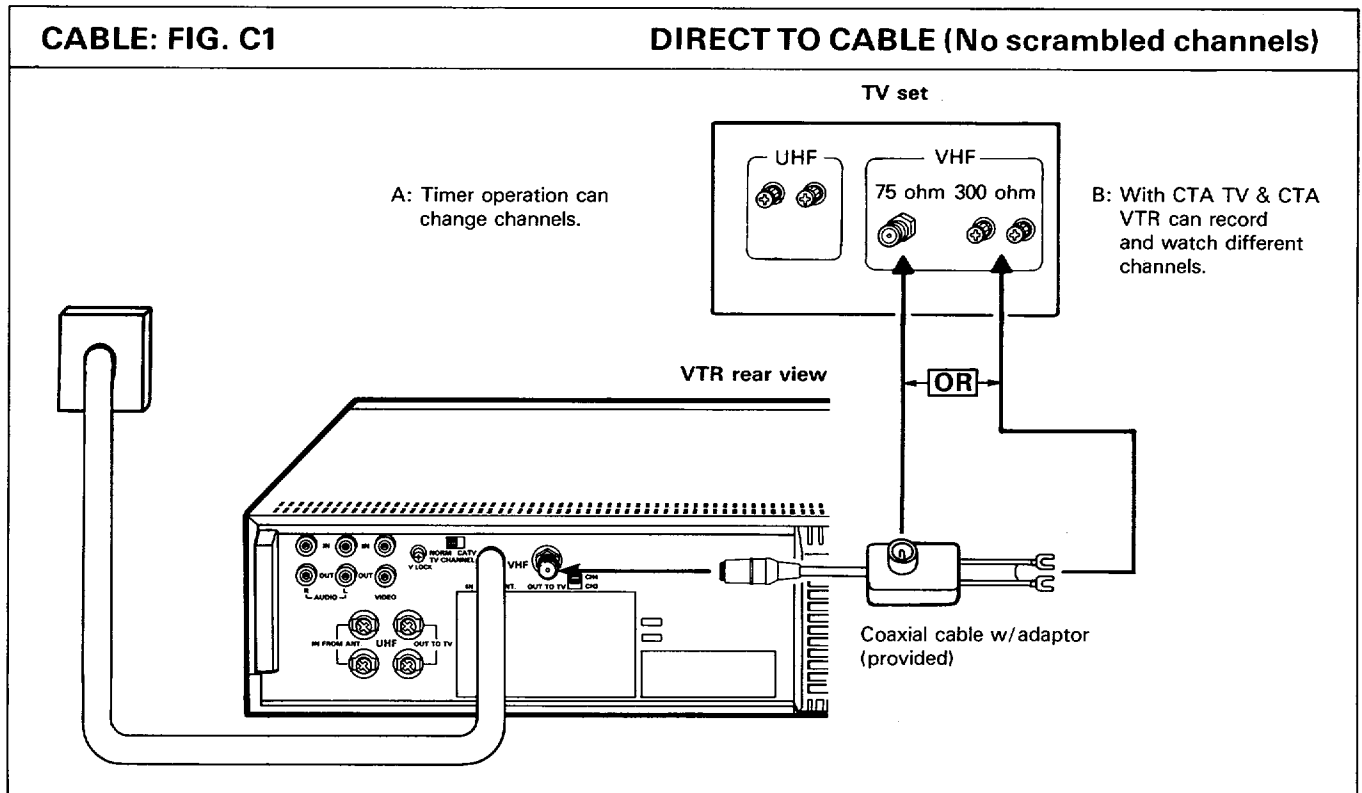

Setting VTR Channels for Cable

Any channel has not been preset until you program active channels as described below. See page 15 for complete information.

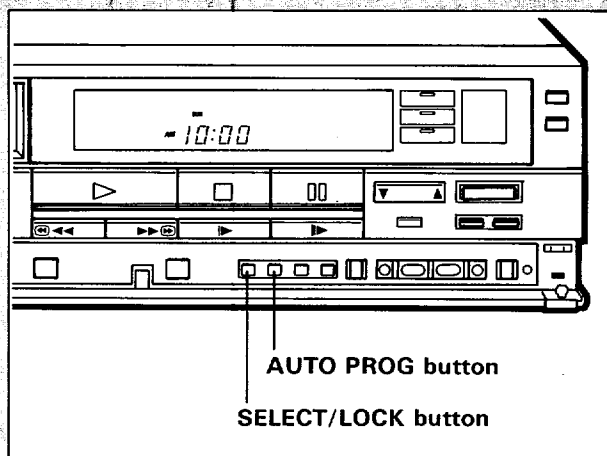

1. Set the VTR/TV select switch to the VTR position and set the channel selector of the TV to the Video channel output by the VTR (CH3/4 setting on RF modulator).

2. Set NORM/CATV switch on the rear of VTR to the CATV position.
3. Press the SELECT/LOCK button once in the secondary control's door. (The channel number will be flashing.)

NOTE: Pressing the button twice will lock the display. If you have pressed it twice, press it once more.

4. Press the AUTO PROG button. The tuner will automatically cycle through all available channel in the area and place them in the tuner's memory. This takes about 30 seconds. The channel number will stop changing when the tuner is finished cycling.
5. Press the SELECT/LOCK button once. Programming is now complete. You can view several channels through the TV using the CHANNEL UP/DOWN button. If not, recheck your switches, connections, and TV fine tuning. Setting TV fine tuning is often easiest by playing a pre-recorded tape.

Cable Connection Using Cable Box Only

Interconnect as in figure C2.

1. Set the TV, Cable Box, and VTR power ON. Select a channel on the Cable Box.
2. Set the VTR/TV switch to the VTR position, and set the channel selector of the TV to the Video channel output by the VTR (CH 3/4 setting on RF modulator).
3. Using Channel Up/Down on the VTR, select the channel used for Cable Box output to the TV. You should be able to view the Cable Box output in only one VTR channel setting. If you are correctly set to the Cable Box, changing the channel setting of the VTR to any other channel will provide only a snowy picture. If no picture is obtained, re-check your connections and TV tuning to the VTR output channel. Setting TV tuning to view the VTR output is often easiest by playing a pre-recorded tape.

The VTR should now be set to tune the Cable Box. To record from the Cable Box, the Cable Box must be turned ON. If the Cable Box is used to control TV power, and you do not wish to have the TV on during Recording or Timer Recording, turn the TV OFF with the power switch on the TV. If the Cable Box controls the TV volume using a Remote Control, the volume setting must be set to normal.

Timer Recording: When you program the Timer for unattended recording, set the VTR to select the VTR channel used to view the Cable Box. The same VTR channel setting must be used for all timer programs. The VTR is unable to control channel selection when it is used with the Cable Box. The VTR can only select the Cable Box or no picture.

Before leaving the VTR to perform Timer Recording, be sure to activate the timer mode, set the Cable Box power ON, and set the channel on the Cable Box to the channel you want to record.

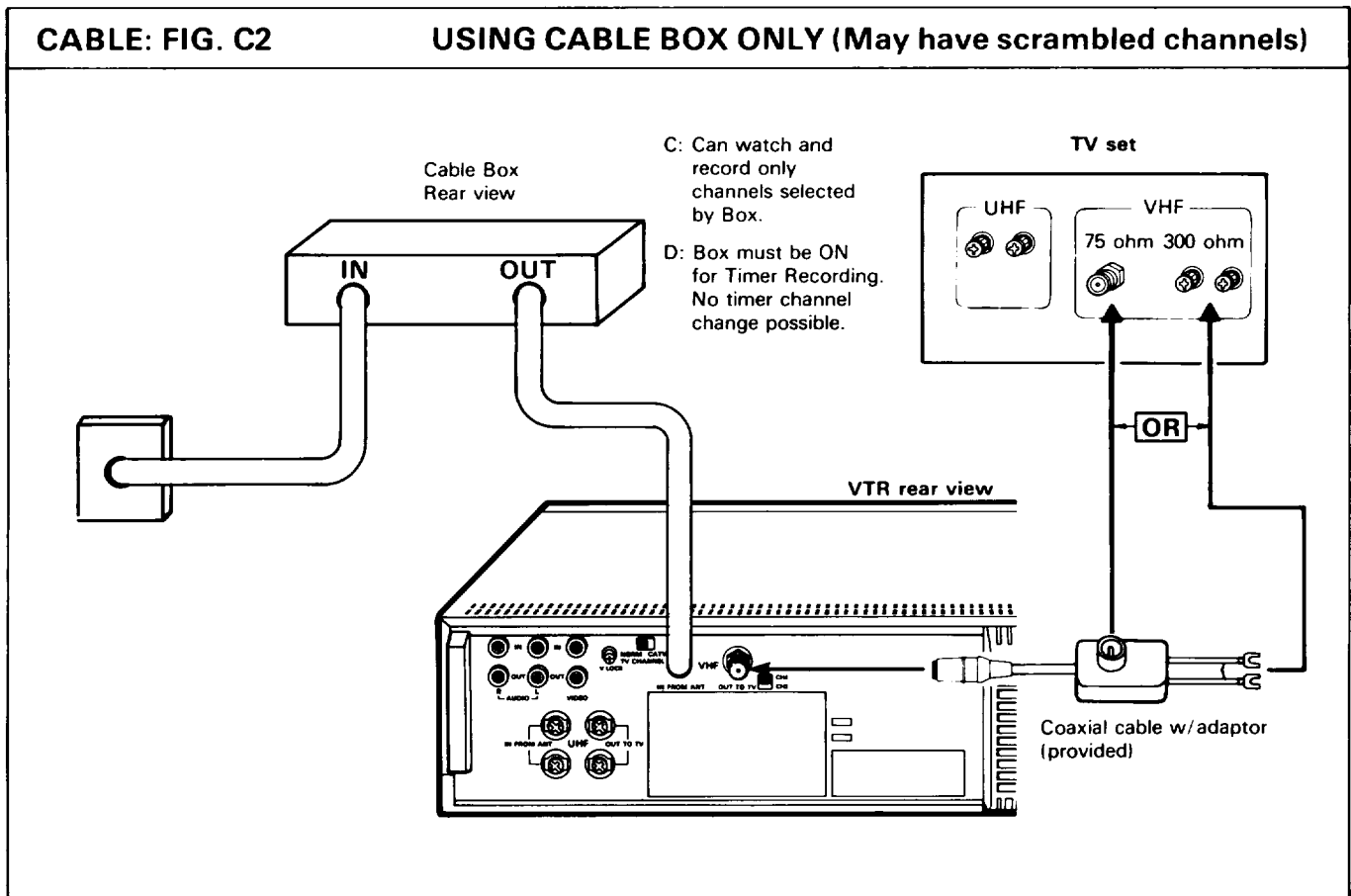

ACCESSORIES REQUIRED FOR OPTIONAL CABLE CONNECTIONS – NOT PROVIDED
 (These items can be purchased at your local electronics supply store.)

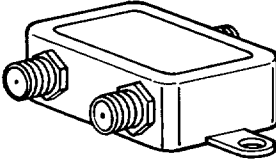
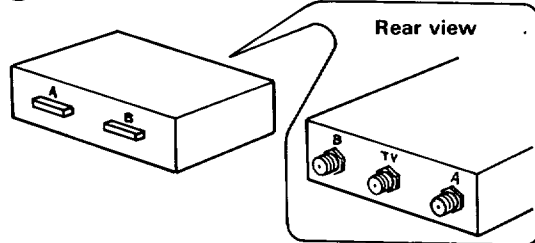
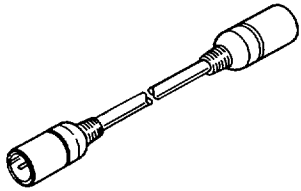
<p>1</p> 	<p>2</p> 	<p>3</p> 
<p>2 WAY SPLITTER (2 used)</p>	<p>A/B SELECTOR SWITCH (2 used)</p>	<p>COAX CABLE (7 used)</p>

CABLE FIG. C3

DIRECT OR USING BOX

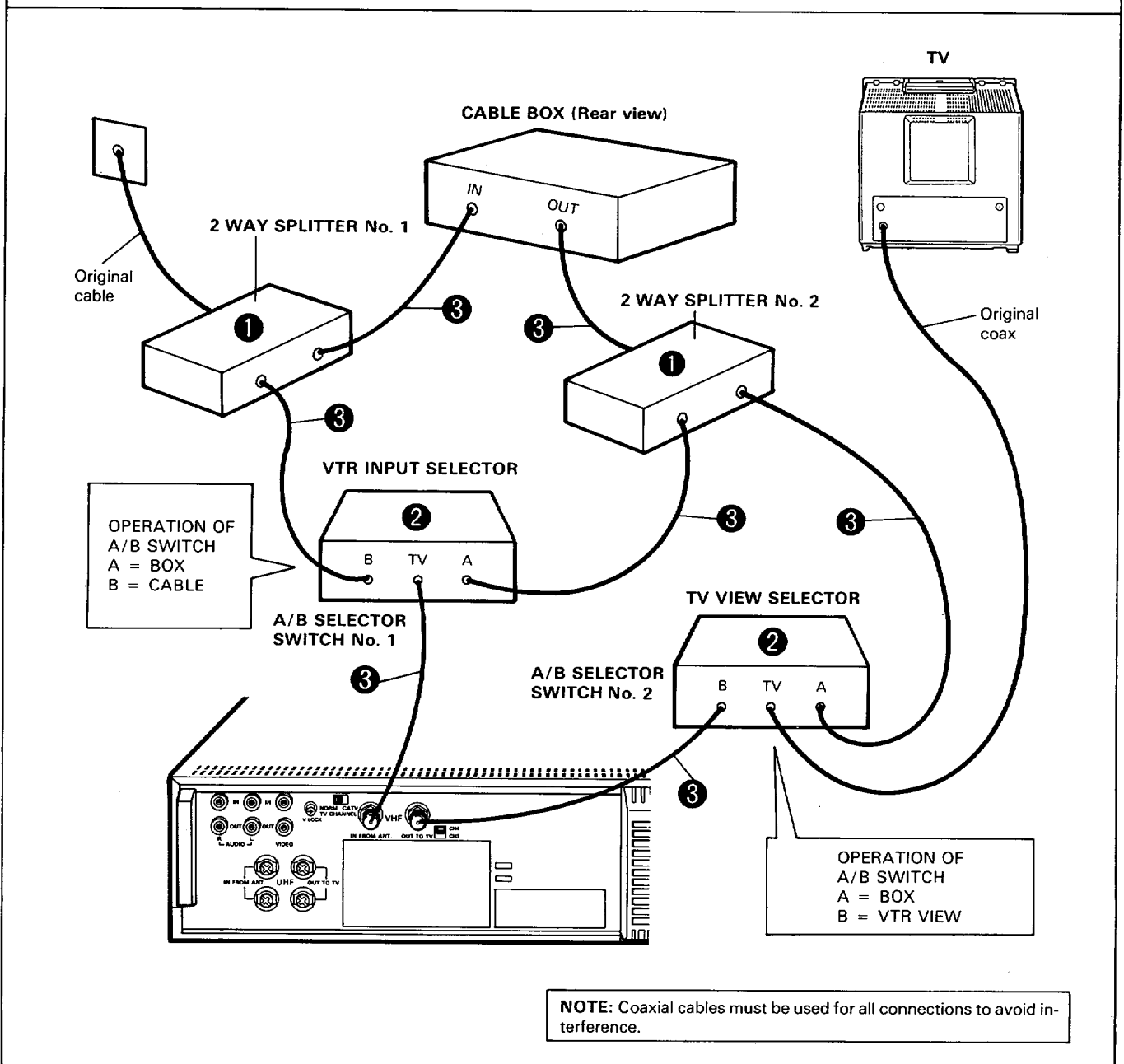

Cable Connection Direct or Using Cable Box

When using figure C3 with a non-scrambled cable system, the VTR Input Selector Switch No. 1 and the 2 Way Splitter No. 2 can be omitted, along with the coax interconnecting the two. Connect the VTR Input directly to splitter No. 1, and the cable box Output directly to A/B switch No. 2.

Function of Accessories

2 Way Splitter No. 1: Divides the cable signal so the signal is provided to the VTR and the Cable Box.

A/B Selector Switch No. 1, VTR Recording Input Selector: Used to select the Source for VTR use. In one position, the cable can be recorded directly. In the other position, the VTR can record the Cable Box.

2 Way Splitter No. 2: Divides the signal from the Cable Box so the VTR can record it, or it can be viewed on TV.

A/B Selector Switch No. 2, TV Viewing Switch: Used to allow the TV to View the Cable Box while the VTR is recording Direct cable sources. In the other position, TV can view VTR Recording or Playing. (VTR/TV switch of video tape recorder must be in VTR mode.)

Operation: After completing connections, set A/B No. 2 to A position. Verify cable channels to TV. In this position, the TV and Cable Box can be used as previously, except when making unattended recording of the Cable Box. Then the Cable Box power must remain ON. To view what the VTR is Recording or playing, set the switch to position B. Tune the TV to the VTR output channel, and set the VTR/TV Switch to the VTR mode.

Operation of VTR

When the VTR Input Selector Switch A/B No. 1 is in position A, the VTR can record the Cable Box. One channel position of the VTR should be set to tune the Cable Box. Channel position 01 is recommended. Set the VTR as in the section for Using Cable Box Only, when using position A.

When the A/B No. 1 is in position B, the VTR operates as indicated in Direct Connection to Cable. Refer to Setting channels for Cable.

Remember that when making a Timer Recording using the Cable Box, the Cable Box channel must be programmed into the Timer, the A/B No. 1 switch must be set to A, and Cable Box power must be left ON. When recording the Cable directly, be sure to set the switch to position B. The VTR cannot select between the Cable Box and Direct Cable inputs, so unattended recordings of both sources alternately should not be programmed unless someone is available to change the setting of switch A/B No. 1 during Timer operation.

CHANNEL TUNING

The automatic programming feature makes it easy and convenient to program the TV station into the tuner's memory. The tuner's memory is empty, however, until you program active channels described below.

Automatic programming is usually a "one-time" procedure, but you will need to repeat it if you move to a location that has different channels, or if the power is interrupted for an extended period.

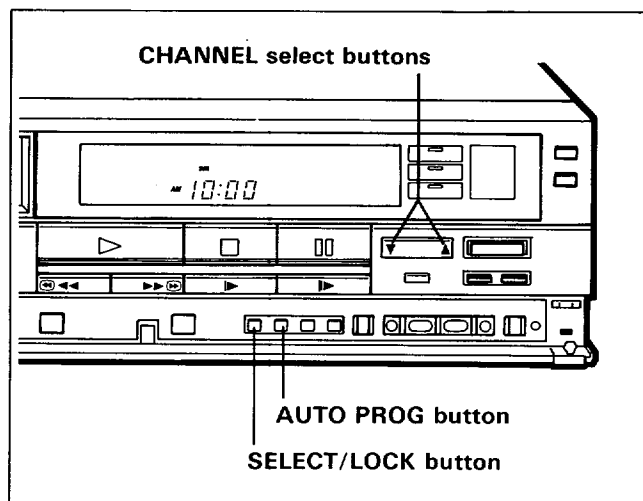

1. Turn on the TV and VTR.
2. Set the TV to channel 3 (or 4).
3. Set the RF converter switch of VTR to channel 3 (or 4).
4. Set the NORM/CATV switch on the back of the VTR to the NORM position if your VTR is connected to a home antenna system. Set the switch to the CATV position if your VTR is connected to a cable TV system.
Note: In the NORM position your VTR receives local VHF channels 2 through 13 and UHF channels 14 through 83. In the CATV position the VTR receives cable channels 2 through 13, A through W, W+1 through W+12, A-2 and A-1. (These channels are sometimes designated 2 through 48 plus 98 and 99.)
5. Press the SELECT/LOCK button once. The channel number will be flashing.
6. Press the AUTO PROG button.
The tuner will automatically cycle through all available channels in the area and place them in the tuner's memory. This takes about 30 seconds. The channel number will stop changing when the tuner is finished cycling.
7. Press the SELECT/LOCK button once.
The channel number will stop flashing. Programming is now completed. You can select the active channels by pressing the CHANNEL select buttons.

Eliminating unwanted preset channels

You may want to have only a few favorite channels in the tuner's memory so you can select them more quickly with the CHANNEL select button.

Occasionally automatic programming may include a vacant channel in the tuner's memory if there happened to be some sort of "noise" or "stray signal" on the channel when the tuner was programmed. This procedure explains how to delete any unwanted channels from the tuner's memory.

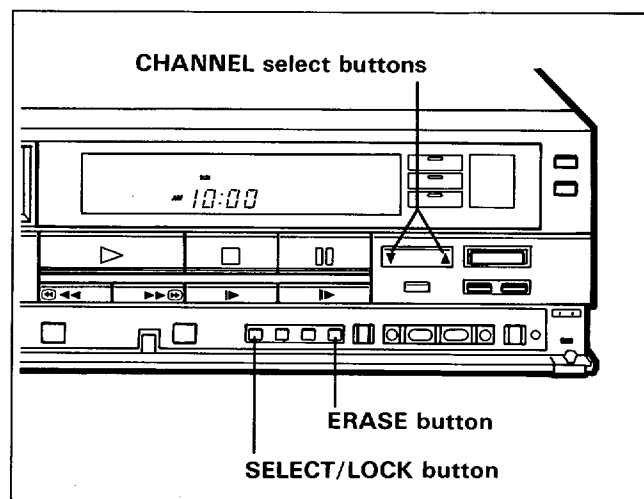

1. Press the SELECT/LOCK button once. The channel number will begin flashing.
2. Press the CHANNEL select button until the unwanted channel is tuned.
3. Press the ERASE button.
The sound will go off indicating the channel has been erased from memory.
4. Repeat steps 2 and 3 until all unwanted channels have been eliminated.
5. Press the SELECT/LOCK button once.
The channel number will stop flashing to tell you the tuner is in its normal operating mode.

Notes:

1. The channel numbers flash when the tuner is in the programming mode, and the CHANNEL select buttons will select every channel, whether or not it is in the tuner's memory.
2. The channel numbers do not flash when the tuner is in the normal operating mode, and the CHANNEL select buttons will select only those channels in the tuner's memory.
3. Pressing the numbered button on the remote control unit selects the channels you deleted from the tuner's memory.

Adding channels to the tuner's memory

You may have deleted a channel from the tuner's memory and want to put it back. Occasionally automatic programming may "miss" an active channel because the signal is very weak or because the channel happened to be "off the air" when the tuner was programmed. Use this procedure to add any channel in the memory.

NOTE: If you view and record one or more local UHF channels, you must first set the VTR to the NORM position, then preset the channels to the tuner's memory. After setting the NORM/LOCK switch on the back of VTR to the NORM position,

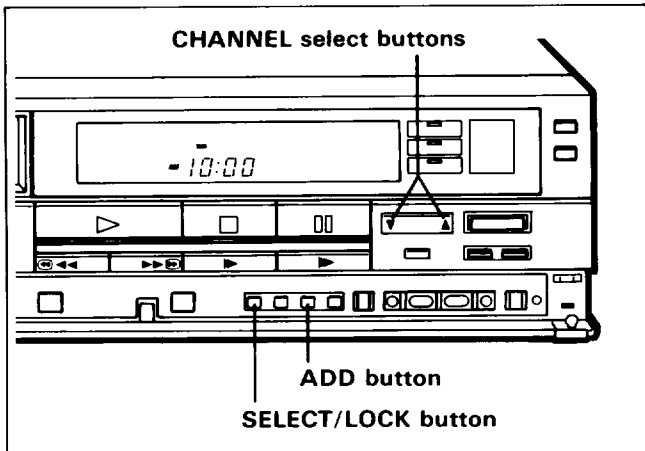

Your VTR can preset the "AUX" position by automatic programming. This AUX position is used to view or record the program input at the VIDEO IN and AUDIO IN on the back of VTR. The "AUX" position can be eliminated for CHANNEL up/down selection and also can be re-entered in memory by following the steps on "Eliminating unwanted preset channels" and "Adding channels to the tuner's memory".

1. Press the SELECT/LOCK button once.
The channel number will begin flashing.
2. Use the CHANNEL or the numbered button on the remote control unit to select the channel you want to add to the memory. There will be picture but no sound at this time.
3. Press the ADD button.
The sound will come on indicating the channel has been added to the memory.
4. Press the SELECT/LOCK button once.
The channel will stop flashing to tell you the tuner is in its normal operating mode.

■ CATV CHANNEL TABLE

Channel Number on Display	02	03	12	13	14	15	16	34	35	36	37	38	47	48	..	98	99	01
CATV BROADCAST CHANNEL corresponding to above Channel Number	2	3	12	13	A	B	C	U	V	W	W+1	W+2	W+11	W+12	..	A-2	A-1	-

VIDEO CHANNEL SETTING

The RF converter changes the video and audio signals from the tuner or tape playback, to a standard television broadcast signal on channel 3 or 4. To obtain video recorder output on either channel 3 or 4, set the RF converter switch to CH 3 or 4 whichever channel is unused in your area.

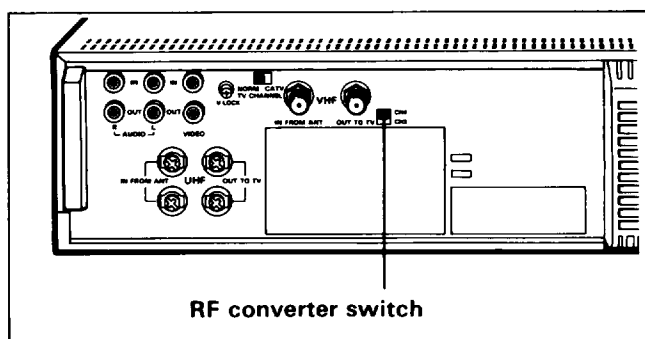

CLOCK TIME SETTING

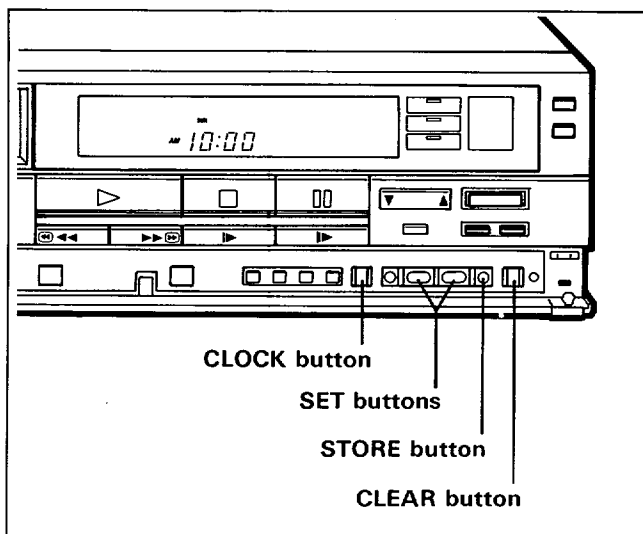

- When VTR is plugged into an AC outlet for first time, the clock display shows "--:--".

The clock is set using the CLOCK, SET and STORE buttons. The CLOCK button selects the clock setting mode. The SET buttons advance the Day, Hours or Minutes. The STORE button stores the Day, Hours or Minutes. After the Day is entered with STORE, the next press of the STORE button will enter the hours, and next press will enter the minutes. To indicate the "DAY" mode, the day will flash. To indicate the "HOUR" mode, the hours digits will flash. To indicate the "MINUTE" mode, the minutes digits will flash. When the STORE button is pressed, the flashing digits will be stored in memory.

If you input erroneous information by mistake during clock setting, press the CLEAR button then input correct information again.

Before setting the clock, program your VTR tuner. (See page 15.)

1. Press the CLOCK button.

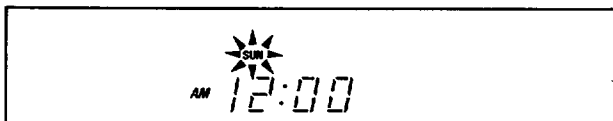

2. Press the SET button (+ or -) repeatedly to select the present day of the week. Hold the button down to advance rapidly. When the present day of the week appears, press the STORE button.

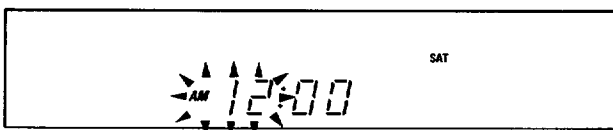

For example, the diagram shows that Saturday (SAT) has been set.

3. Press the SET button (+ or -) to set the present hour. Hold the button down to advance rapidly. Press the STORE button when the present hour appears.



For example, the diagram shows that "AM 10" hour has been set.

4. Press the SET button (+ or -) to set the minute. Hold the button down to advance rapidly. Press the STORE button when the present minute appears.

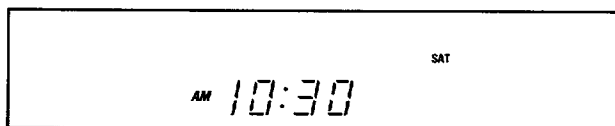

For example, the diagram shows that "30" minutes has been set.

Now the clock has been set to the correct time of day.

For zero second setting, set the minutes to one minute ahead of present time and press the STORE button when the exact start of the next minute is reached.

Note: • A built-in timer circuit will preserve your clock and program settings for about 5 minutes in the event of a power interruption. But if your clock display shows "--:--", your home had a power failure for more than about 5 minutes. The time should be reset.

- 12:00 AM is midnight; 12:00 PM is noon.

NORMAL TV VIEWING

You do not need to disconnect VTR from your TV set to watch TV. When you turn off the POWER switch on your VTR, the VTR automatically switches to "TV".

To watch TV, turn on TV and select a channel as usual.

CASSETTE TAPES

Insertion and removal of cassettes

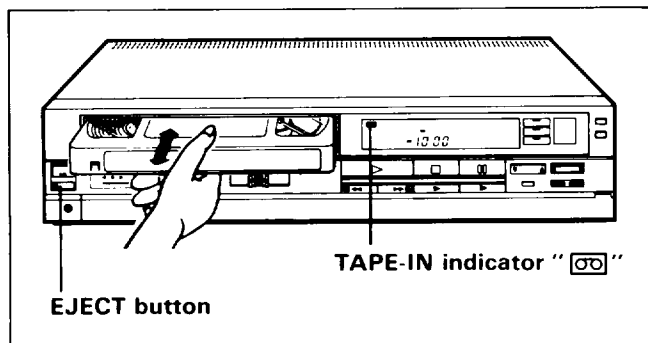

Insertion

1. Insert the cassette.

Note:

- When the cassette is loaded, power is turned on automatically and TAPE-IN indicator lights.
- When a cassette is inserted diagonally or too quickly into the cassette compartment, the cassette cannot be drawn into the VTR. In this case do not pull or push the cassette forcibly. The cassette will be ejected in a few seconds. Push it in again gently.

Removal

1. Turn on power.
2. Press EJECT button.
3. Remove the cassette.

Types of video cassette

Use video cassettes with the **VHS** mark in this VTR. The table below shows how to distinguish difference in recording time of cassettes.

TYPES	RECORDING TIME		
	SP	LP	EP
T-30	30 min.	60 min.	90 min.
T-60	60 min.	120 min.	180 min.
T-120	120 min.	240 min.	360 min.
T-160	160 min.	320 min.	480 min.

To avoid erasing a recording

Break off the safety tab using a screwdriver or similar tool.

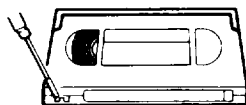

To re-record on a cassette which has its safety tab removed

Cover the hole with cellophane tape.

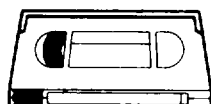

Refer to the instructions included with cassettes for more information.

RECORDING TV PROGRAMS

■ Recording normal off-the-air TV program

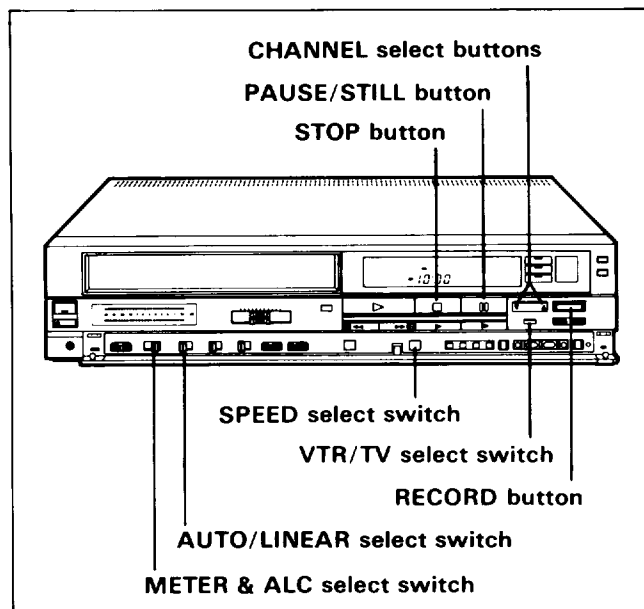

1. If you wish to view a program being recorded, turn on TV and select the channel 3 or 4 for your video channel.
2. Insert Cassette.
VTR power is turned on automatically. Be sure to check that the record safety tab is not missing.
3. Set SPEED select switch to "SP", "LP" or "EP".
4. Set the VTR/TV select switch to "VTR" (VTR indicator lights) if you wish to view a program being recorded.
5. Select channel to be recorded.
6. Set the METER & ALC select switch to "ALC ON" position.
7. Set the AUTO/LINEAR select switch to AUTO position.
8. Press RECORD button. Recording will start.
9. Press PAUSE/STILL button to stop recording temporarily. Press again to release.
Note: To prevent tape damage, do not leave the unit in the pause mode for more than 5 minutes.
10. Press STOP button to stop recording.

To record one program while viewing another

You can record one program while viewing another by merely selecting the channel on your TV after setting the VTR/TV select switch to "TV". The recorded program can be viewed later at your convenience.

To change the channel to be recorded while in record mode

During recording, the channel lock function operates and channel cannot be changed if the channel select button is pressed.

If you wish to change channel, proceed as follows.

1. Press the PAUSE/STILL button.
2. Change channel desired.
3. Press the PAUSE/STILL button to release record pause mode.

■ **Recording broadcast stereo TV**

The basic procedure for recording broadcast stereo TV is the same as it is for normal off-the-air recording. The STEREO indicator will come on when the station is broadcasting in stereo. Before you begin recording, be sure the STEREO switch is set to ON position. Then follow the same steps 1 through 10 of "Recording normal off-the-air TV program" on page 18.

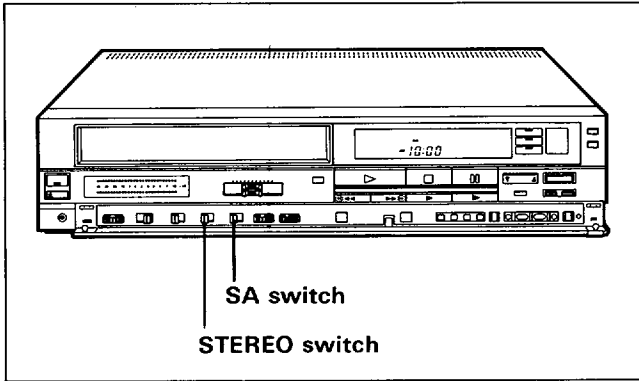

Note: If the stereo signal is noisy (from a weak station, for example) set the STEREO switch to the OFF position. The audio you receive will be monaural. Monaural reception may improve a noisy stereo signal. (The OFF position should only be used if the stereo reception is too noisy for enjoyable listening.)

■ **Recording second audio program (SA)**

Some station transmits a Second Audio. To record Second Audio set the STEREO switch to ON and SA switch to ON position. When the station broadcasts an SA, the SA indicator will turn on. Press the RECORD button to start recording. Your VTR will record the SA instead of the normal audio.

The SA will be recorded on the Linear audio track in monaural and stereo sound or main language will be recorded on Hi-Fi track.

Note: Set the AUTO/LINEAR select switch to LINEAR position to listen to the SA during recording or to play back the SA recorded on the tape.

Tape counter

This indicates the amount of video tape transported as a number.

Press the RESET button to set the counter reading to "0000" when starting recording or playing back.

Note the number on the Tape counter at the beginning and end of each program you record. This will allow you to use the counter to find the desired program later.

Counter memory function

This is useful if there is a section of tape you want to view immediately after recording or you want to return to the same point several times.

1. Begin recording or playing back a tape.
2. At the point where you want playback to begin, reset the tape counter to "0000" by pressing the RESET button.

3. Continue to play or record.
4. Press the STOP button when recording or playback finishes.
5. Press the MEMORY button to turn on "M" indication on the display.
6. Press the REWIND button.

The tape will automatically stop at the pre-selected "0000" position.

Actually, so that you won't miss the very first part of the program to be viewed, the tape will stop slightly prior to "0000" at approximately the "9997" position.

Note: The tape will also automatically stop at "0000" during fast forwarding.

Recording level adjustment

When recording is performed with the METER & ALC select switch set to "ALC ON", the sound is automatically recorded at the optimum level.

However, when recording sound from audio equipment, sound may be more faithfully recorded and played back by manually adjusting the recording level with the METER & ALC select switch set to "ALC OFF".

To adjust the audio recording level, set the METER & ALC select switch to "METER ON" and "ALC OFF", then adjust the Recording level control so that the red indicators near 4 dB light occasionally, when especially loud portions are being recorded.

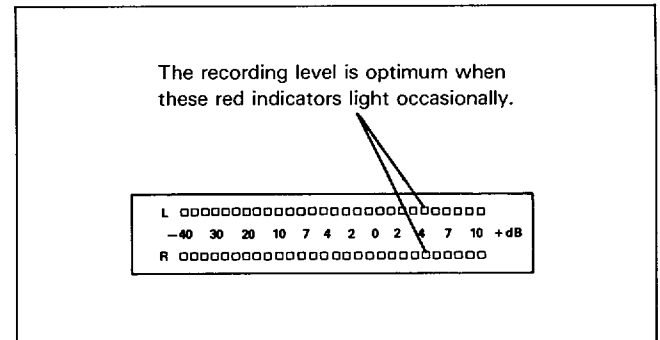

Automatic rewind

The tape will stop and automatically rewind when the end of the tape is reached.

This function does not operate during Timer recording and Instant recording.

Rewind shut off

If power switch is pressed during rewind operation, power will be turned off automatically after the tape has been completely rewound.

INSTANT RECORDING

Instant recording timer (IRT) allows you to start an unattended recording without programming the timer. It is convenient if you are interrupted while viewing a program and want to record the balance of it. By using the delayed start feature you can delay the recording start up to 24 hours. Although you do not need to program the timer for IRT, the clock must be set.

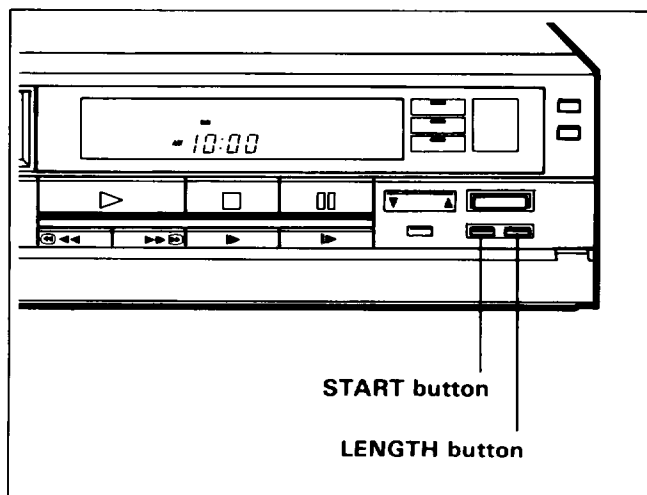

IRT with immediate start

1. Follow the steps 1 through 7 on "RECORDING TV PROGRAM". (See page 18.)
2. Press the LENGTH button to select the recording time. Pressing the button once sets the timer to "0:00". The recording time changes in hour and minute in the order of 0:30, 1:00, 1:30, 2:00, 3:00 and 4:00 every time the button is pressed. IRT will begin when 0:30 is displayed and the Ⓜ and IRT indicators will come on. During recording, the remaining IRT time appears on the timer display.
3. At the end of recording the display reads 0:00; the VTR will automatically shut off.

Note:

1. IRT feature does not operate during play and unattended recording modes.
2. If the LENGTH button is pressed during rewind operation, VTR enters the IRT mode after rewinding tape.

Delayed start IRT

You can delay the start of an IRT by using the START button.

1. Follow the steps 1 through 7 on "RECORDING TV PROGRAM". (See page 18.)
2. Press the START button to set the start time. The start time may be set to begin on any hour or half hour, up to 24 hours from present. For example, the present time is 9:15 AM and you want to record a program that starts at 10:30 AM. Just press the START button three times.

3. Press the LENGTH button repeatedly to select the desired recording time. The recording time changes in hour and minute in the order of 0:30, 1:00, 1:30, 2:00, 3:00 and 4:00 every time the button is pressed.
4. Turn off the VTR power.

The Ⓜ indicator will come on, and IRT will begin at the time you selected.

During recording, the remaining IRT time appears on the timer display.

Note: Delayed IRT will not begin if the VTR is turned on at the start time.

Recalling the IRT

Press the START or LENGTH button only once to recall the start time and recording time. The display shows both start time and recording time for about 8 seconds and returns to present time of day.

Note: To recall the recording time, press the LENGTH button only once. If you press the button twice or more, the recording time will be changed.

To extend the recording time

The recording time can be extended anytime by pressing the LENGTH button. The timer display will reset to 0:30, 1:00, 1:30, 2:00, 3:00 or 4:00 as selected.

To cancel IRT

You can clear IRT by pressing the LENGTH button until time remaining is 0:00, or by pressing the POWER button and then the STOP button within 10 seconds.

Note:

1. When the recording is not taking place, press the LENGTH button until the display reads 0:00 to cancel IRT.
2. To change the IRT program, the previous information must be first cleared.

PLAYBACK

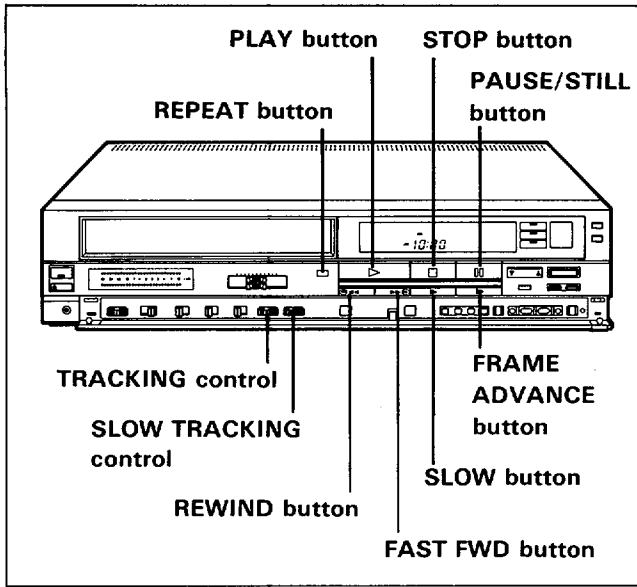

1. Insert the cassette.
VTR power is turned on automatically.
2. Turn the TV on and select the video channel.
3. Press the PLAY button.
4. Press the STOP button to stop playback.

Tracking control adjustment

When playing prerecorded tapes or those recorded on units other than your own, black and white streaks may appear on your TV screen. If this occurs, move the TRACKING control slowly in either direction until the streaks disappear. When playback of this particular tape is over, readjust the TRACKING control to its original position. The original position is normally in the center position.

Note: When a scratching noise is heard during playback of Hi-Fi VHS audio (with Hi-Fi indicator lit), turn this control to adjust for optimum sound.

Still playback

Press the PAUSE/STILL button to stop the picture on the screen during playback.

During still playback, press the PAUSE/STILL button to return to normal playback, or the STOP button to enter the VTR to the stop mode.

Note:

- If you see vertical shaking on the TV screen in the still playback mode, rotate the V. LOCK control on the rear of the VTR to minimize shaking.
- When the still playback mode continues for about 5 minutes, the VTR switches to the stop mode automatically to prevent damage to the tape.
- The playback picture will have some noise in the still playback mode.

Frame advance

When you hold F. ADV (Frame Advance) button down during STILL (play-pause) mode, tape will be played back frame by frame. Operates only after PAUSE/STILL button has been pressed.

Visual search

This allows you to view the picture from a recorded tape at high speed in both the forward and reverse directions.

Press the PLAY button to play a tape, then press either the VISUAL SEARCH button REW or F.FWD. Pictures can be viewed at high speed in either the forward or reverse direction.

Note: The playback picture will have some noise in the visual search mode.

Slow playback

When you press SLOW button during playback, the tape will be played back at a speed about 10 times slower than the normal speed.

Press PLAY button to return to normal playback mode or press STOP button to stop tape movement.

NOTES:

1. During slow playback SLOW TRACKING control can be adjusted to minimize noise bands.
2. When the slow mode continues for more than about 5 minutes, the VTR will automatically change to play mode to protect the tape.

Repeat feature

Use this feature to repeat the scene you have just viewed during playback.

1. During playback, press PLAY button at the scene where you want the repeat of the playback to start. The playback continues.
2. Press REPEAT button. The tape is automatically rewound to the position where PLAY button was pressed, and playback is repeated.

Stereo playback

If your TV has a stereo amplifier for TV sound, connect the stereo audio outputs from the VTR to the stereo audio inputs of TV as shown below.

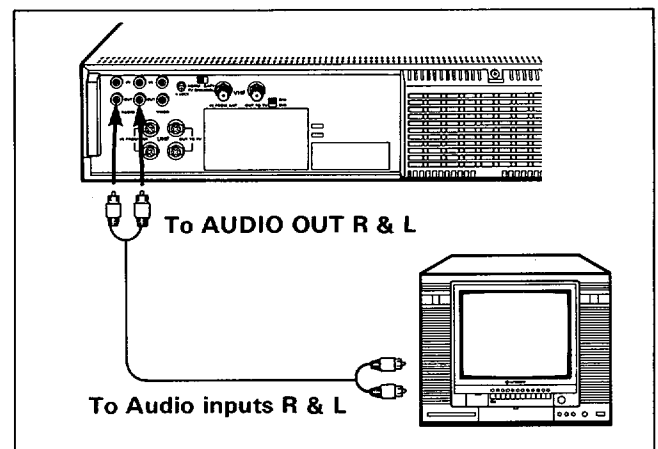

If your TV does not have a stereo amplifier, you will probably want to connect the audio outputs from your VTR to your stereo system. See page 26 for connections.

NOTE: Connecting the audio cable permits playing stereo audio through the stereo system or stereo TV. (Only monaural sound is available when the VTR is played via the VHF antenna output.)

TIMER RECORDING

The programmable electronic clock/timer permits the unattended recording of up to 4 preselected programs, including one program on the same day of each week or one program at the same time Monday through Friday. It can be preset up to 14 days in advance to record your favorite programs. It turns the unit on and off and changes channels automatically.

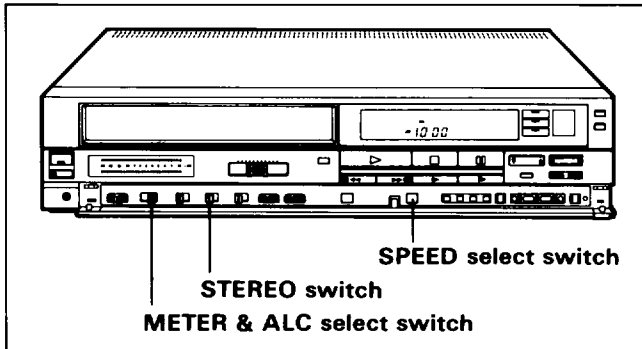

- Your TV does not have to be on to make a recording because the VTR records TV programs without the aid of your TV. Your TV is used only to view the program during recording or play.
1. Insert the Cassette.
 2. Set the SPEED select switch to "SP", "LP" or "EP".
 3. Make sure that the METER & ALC select switch is set to ALC ON and the STEREO switch is set to ON.
 4. Set the program timer. "START (ON) TIME", "STOP (OFF) TIME", "DAY" etc. See below.

Programming the timer for unattended recording

For unattended recording the timer needs to know what **day** to make the recording, the **time to start**, the **time to stop**, and the **channel to be recorded**.

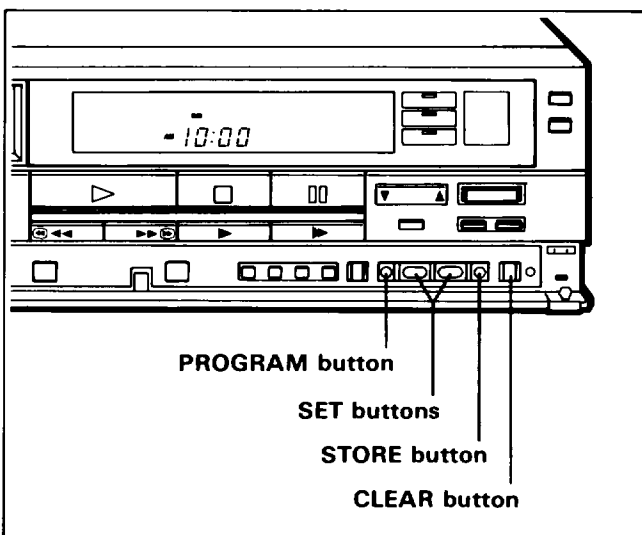

The timer is programmed using the PROGRAM, SET and STORE buttons. The PROGRAM button selects the timer programming mode. The SET buttons advance the Program indicators, Channel, Day, Hours or Minutes for recording. The STORE button stores

them. The digits flash in sequence, so input the correct data to the flashing digits. When the STORE button is pressed, the flashing digits will be stored in memory. If you input erroneous information by mistake when programming the timer, press the CLEAR button and input the correct information again.

1. Press the PROGRAM button.

Program indicators (1 through 4) flash to indicate which memory positions have not been programmed. If a memory has been programmed, its indicator will not flash.

Note: You should determine which memory positions have not been programmed before entering new programming information. New information automatically erases previous programming.

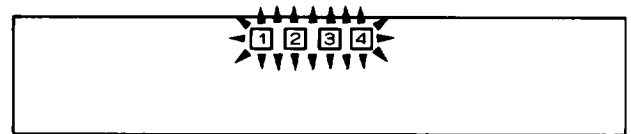

2. Press the SET button (+) to select the program indicator to be programmed. Program indicators (1 through 4) light, in sequence, across top of digital display. Press the STORE button when the desired program number is displayed. Channel indicator starts flashing.

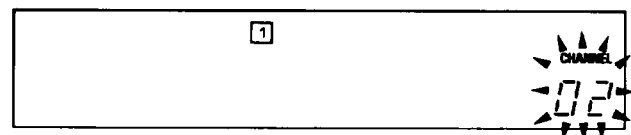

For example, diagram shows program "1" has been set.

3. Choose the channel to be recorded by pressing the SET or CHANNEL select button. Then press the STORE button. "1W" appears and the present day flashes.

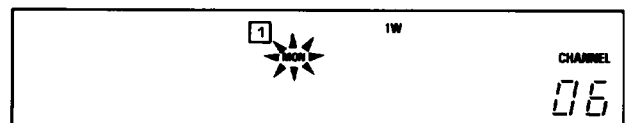

4. Press the SET button to select the day of recording. Make sure desired Week indicator (1W or 2W) lights. Continuing forward will advance timer to Week two. Press the STORE button after selecting the day of recording. "AM 12" hour starts flashing.

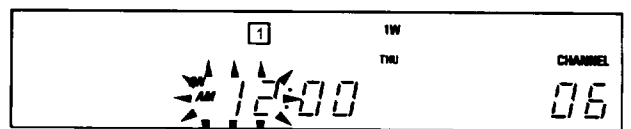

For example, diagram shows recording on Thursday within 1 week from today.

To record on a specified day at the same time each week: Press the SET button until the "WKL" indicator lights and then press the SET button to select the day of recording. Then press the STORE button.

The diagram shows a digital display with a '1' in a box at the top left. To the right is 'WKL'. Below 'WKL' is 'TUE'. The time '12:00' is displayed in the center, with 'AM' on the left and 'PM' on the right. On the far right, 'CHANNEL' is written above the number '06'.

To record at the same time on Monday through Friday: Press the SET button until Monday through Friday indicators light, then press the STORE button.

The diagram shows a digital display with a '1' in a box at the top left. Below it are the days 'MON TUE WED THU FRI'. The time '12:00' is displayed in the center, with 'AM' on the left and 'PM' on the right. On the far right, 'CHANNEL' is written above the number '06'.

5. Select the hour for recording to start by pressing the SET button. Hold down button to advance rapidly. Press the STORE button after selecting the hour for recording to start. "00" minutes starts flashing.

The diagram shows a digital display with a '1' in a box at the top left. Below it are '1W' and 'THU'. The time '8:00' is displayed in the center, with 'ON' and 'PM' on the left. The '00' minutes are flashing.

For example, the diagram shows "PM 8" hours has been set.

6. Select the minutes for recording to start by pressing the SET button. Hold down button to advance rapidly. Press the STORE button after selecting the minute for recording to start. "OFF" will appear and "8" hour starts flashing.

The diagram shows a digital display with a '1' in a box at the top left. Below it are '1W' and 'THU'. The time '8:30' is displayed in the center, with 'ON' and 'PM' on the left. The '30' minutes are flashing.

For example, the diagram shows "30" minutes has been set.

7. Select the hour and minute to stop recording in the same procedures described in steps 5 and 6. Be sure to press the STORE button after selecting the hour and minute. Now, one programming has been completed. After few seconds the display returns the clock time display together with letters "1" automatically.
8. Turn off the POWER switch. The "⊕" indicator will come on.

Notes:

1. If the erase prevention tab is removed, the cassette is ejected automatically and "⊕" indication will flash. Stick a piece of cellophane tape over the erase prevention hole on the cassette to enable recording.
2. The "⊕" indication will flash, if a cassette is not inserted.

To clear a program

1. Press the SET button (+) until desired program indicator flashes. Then start and stop time appear on the display.

The diagram shows a digital display with a '1' in a box at the top left. Below it are '1W' and 'THU'. The time '8:30' is displayed in the center, with 'ON' and 'PM' on the left. To the right, 'OFF' and '10:00' are displayed, with 'PM' below '10:00'. On the far right, 'CHANNEL' is written above the number '06'.

2. Press the CLEAR button.

The display returns the clock time display to show that the programming has been cleared. Be sure to press the CLEAR button while the display shows the start and stop time. The programming does not clear if the CLEAR button is pressed when the display returns the clock time display.

To check programming

Press the SET button (+). The program indicator "1" flashes. If the program No. 1 has been already programmed, both start and stop times are displayed in a few seconds. The display then automatically returns to the present time of day.

The diagram shows a digital display with a '1' in a box at the top left. Below it are '1W' and 'THU'. The time '8:00' is displayed in the center, with 'ON' and 'PM' on the left. To the right, 'OFF' and '10:00' are displayed, with 'PM' below '10:00'. On the far right, 'CHANNEL' is written above the number '06'.



The diagram shows a digital display with a '1' in a box at the top left. Below it is 'SAT'. The time '10:30' is displayed in the center, with 'AM' on the left.

Programming errors

If programs overlap, the VTR will select the program with the earliest start time. When that program is over, the VTR will switch to the next program. If the start times are the same, the VTR will select the programs in numerical order.

To stop a timer recording while in progress

Press the POWER switch and then press the STOP button within 10 seconds. The program that was being recorded will be erased from the timer's memory.

REMOTE OPERATION

You can operate the VTR from a distance using the Infrared Remote Control unit.

Power source of infrared remote control unit

The infrared remote control unit is powered by two batteries (size AA). Insert the batteries (provided) so that their positive ends contact the positive terminals in the battery compartment. The life of the batteries is about one year although it depends on the number of times the unit is used. Replace the batteries when operation is not possible or when the distance becomes too small.

Operation of remote control

To use the infrared remote control unit aim it at the receiver on the front panel of the VTR.

Note: An object in between the VTR and remote control unit may block the invisible light beam and operation will not be possible.

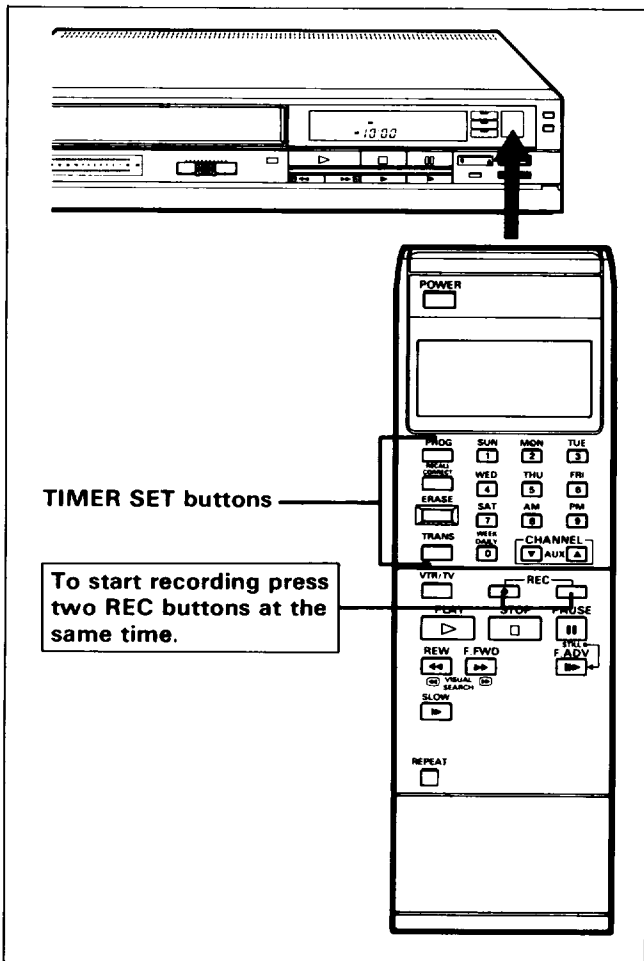

■ To select a channel directly using the Remote Control Unit

Press 10-key buttons [1] to [0] to select a channel of the VTR directly.

For example, to select channel No. 18, press [1] and then [8].

Notes:

1. For single-digit channel numbers, first press [0] and then channel number [1] through [9].
2. Using the Remote Control Unit, you can also directly select the channel which was erased by pressing the ERASE button of the VTR. For example, when channel No. 5 was previously skipped, the channel is not displayed even if the CHANNEL select button on the VTR is pressed, however, it can be displayed when buttons [0] and [5] are pressed.
3. Channel selection can not be done when the programmed information is being displayed on the remote control unit.

■ Programming the timer for unattended recording using Remote Control Unit

Note: If you input erroneous information by mistake when programming the timer, press RECALL/CORRECT button and input the correct information.

1. Turn on VTR.
2. Press PROG button once.
"PROG. No." appears and "1" through "4" flash on the Display.

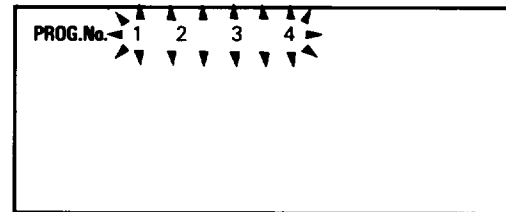

3. Press one of buttons [1] to [4] to select a Program No.
For example, press button [2] to select Program No. 2.

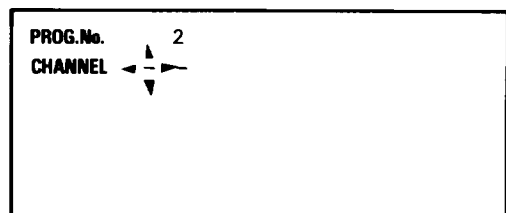

Note: Select the program No. which is not displayed by the display of VTR.

4. Press 10-key buttons [1] through [0] to select the channel to be recorded.

Notes:

1. For single-digit channel numbers, first press [0] and then the channel number [1] through [9].
2. If you want to select "AUX" position which is used to record the program input at the VIDEO IN and AUDIO IN, press CHANNEL select button.

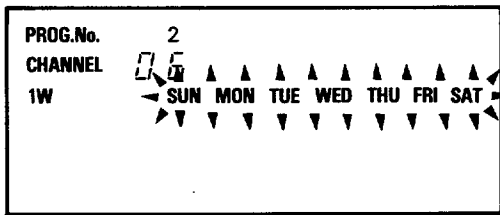

For example, the above diagram shows that "CHANNEL 06" has been set.

5. Select the day for recording.
For example, to select this Saturday, press [7] (SAT).

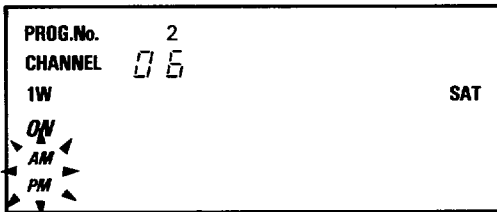

Notes:

1. Display "1W" if the day for recording is within 7 days including today. Display "2W" if the day for recording is between 8th and 14th days. Every time button [0] (WEEK/DAILY) is pressed, 1W changes to 2W, WKL (weekly) and MON through FRI (daily) in sequence.
2. To record at same time every day from Monday through Friday:
Press [0] (WEEK/DAILY) repeatedly so the five week days (MON through FRI) are displayed.

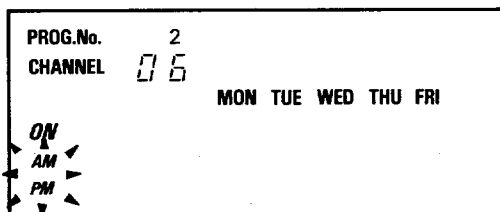

3. To record on a specified day at the same time each week:
Press [0] (WEEK/DAILY) repeatedly so the WKL indicator lights and then press [1] through [7] to select the day of recording.

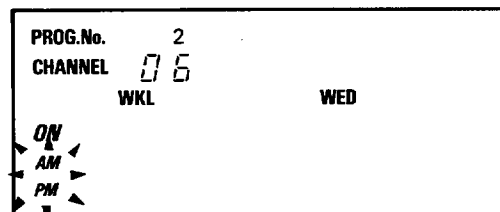

For example, the above diagram shows "WED" on every week has been set.

6. Select AM or PM for the recording to start by pressing [8] (AM) or [9] (PM).

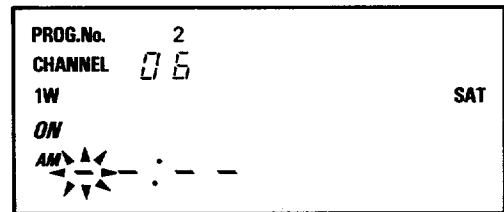

For example, the above diagram shows "AM" has been set.

7. Select the hour and minute for the recording to start by pressing [1] through [0] buttons.
For example, to set "12:15", press buttons [1], [2], [1], [5] in this order.

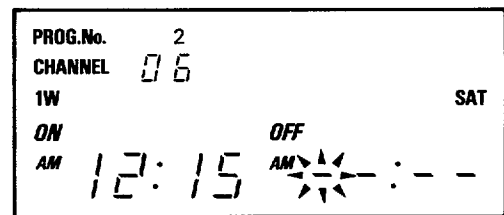

Note: For a single-digit hour or minute press [0] before entering the hour or minute.

8. Select the hour and minute for recording to stop by pressing [1] through [0] buttons.
For example, to set "06:30", press buttons [0], [6], [3], [0] in this order.

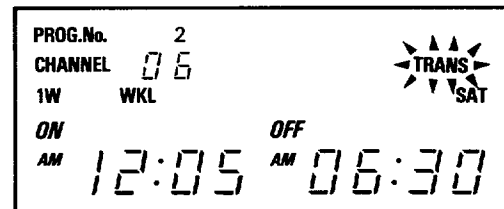

Notes:

1. You do not need to select AM or PM when you are setting the stop time.
2. If you set stop time of more than nine hours after start, the setting will not be accepted.
9. Aim the Remote Control Unit at the receiver in the front panel of the VTR and press TRANS button.

Now the program No. on the display of the VTR will flash for a few seconds and then change to steady lighting.

Programming one event is completed.

Check that a cassette has been loaded in the VTR, then turn off the VTR power.

Notes:

1. The information in the Display of the Remote Control Unit goes off automatically after approx. one minute.
2. Even when the POWER switch on the Remote Control Unit is set to OFF after transmitting the programmed information to the VTR, the information is stored in the memory of the VTR.
3. If you select a channel which is not transmitting a signal (a channel which is not displayed if the channel select button on the VTR is pressed) in step 4, "Err" is displayed by the VTR when the TRANS button is pressed.

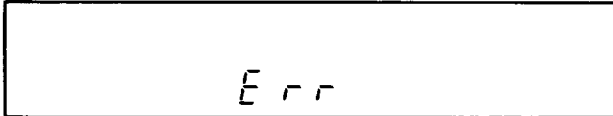

In this case, correct the channel as follows.

1. Press PROG button to disappear the programmed information from the display of remote control unit.
2. Press RECALL/CORRECT button repeatedly until the channel digits flash.
3. Input the correct channel.
4. Press RECALL/CORRECT button repeatedly until "TRANS" flashes.
5. Press TRANS button.

To check the programming

1. Press RECALL/CORRECT button.
The programmed information is shown by the Display of remote control unit.
Note: When 2 or more programs are stored in memory, only the last programmed information is displayed.

To clear the programming

1. Press RECALL/CORRECT button.
The last programmed information is displayed.
2. Press ERASE button.
The programmed information is erased from the Display of remote control unit.
Note: The programmed information which has already been transmitted to the VTR is not erased. Erase it by using the operation buttons of the VTR.

To change the programming information

When you find a mistake after transmitting the programmed information, correct it as follows and transmit the corrected information again to the VTR.

1. Press RECALL/CORRECT button to display the programmed information on the display.
2. Press RECALL/CORRECT button repeatedly until the digit to be corrected flashes.
3. Correct the error.
4. Press RECALL/CORRECT button until "TRANS" flashes.
5. Press TRANS button.

Now the programmed information which was previously transmitted is erased and the correct information is stored in the memory of the VTR.

RECORDING AND PLAYBACK OF SIMULCASTS

Simulcast recording allows you to record a program which is being transmitted simultaneously by a television station and a radio station in stereo. For simulcast recording and stereo playback, you will need audio cables.

CONNECTIONS

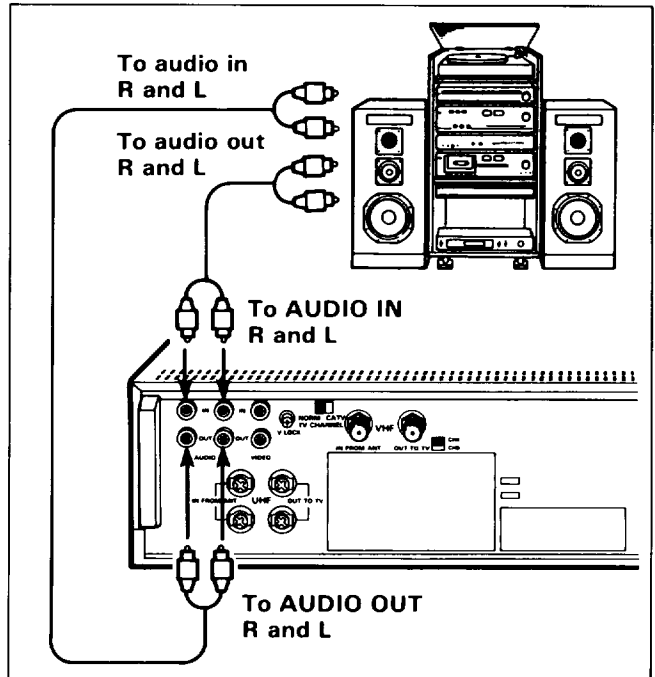

In order to record and play stereo audio with a stereo system, the amplifier or receiver must have an unused set of tape record (L and R) jacks and tape play (L and R) jacks. Some systems have a set of tape jacks for two tape decks, other systems have jacks for only one deck.

If your system has connections for only one deck, and you already have an audio deck connected, you will need to obtain an accessory for connecting multiple audio decks. Please consult your audio dealer.

If you have connections for two tape decks, your audio deck can remain connected to the tape-1 connectors, and you may connect your VTR's audio connections to the jacks for tape-2. The tape record (L and R) jacks of your amplifier should be connected to the Audio Inputs (L and R) of your VTR, and the VTR's Audio Outputs (L and R) connected to the amplifier's tape play jacks. Select the tape switch on the amplifier which matches the VTR's tape connections.

To record simulcasts

1. Connect the audio cable to the AUDIO IN (R and L) jacks of your VTR and to the audio output jacks (right and left) of your stereo system.
2. Set the FM tuner of the stereo system to the FM station broadcasting the simulcast stereo audio.

3. Then follow the steps for RECORDING TV PROGRAMS (page 18) except turn the SC button on (The SC indicator light comes on.).
4. If you want to listen to the program in stereo while recording, turn down the sound of your TV and turn up the sound of your stereo system.

Note: The sound from FM tuner is recorded on Hi-Fi track and the TV sound is recorded on linear track. Change over the AUTO/LINEAR select switch when playing back the tape; you can select the sound on the Hi-Fi or linear track.

To playback in stereo

1. Connect the audio cable to the AUDIO OUT (R and L) jacks of your VTR and to the audio input jacks (right and left) of your stereo system.
2. Then follow the steps for PLAYBACK (page 21), turning down the sound of your TV.

Note: For operation of your stereo system, see its operation manual.

To use the unit as an audio deck

Hi-Fi sound can be enjoyed using this VTR as an audio deck when connected to an audio system.

1. Connect this VTR and the stereo system as for "RECORDING AND PLAYBACK OF SIMULCASTS" on page 26.
2. Insert a cassette.
3. Set SPEED select switch to "SP", "LP" or "EP".
4. Press the CHANNEL select button until the AUX indicator lights up on the display.
5. Set the METER & ALC switch to ALC ON position to automatically control the recording level. See "Recording level adjustment" on page 19 to manually adjust the recording level.
6. Make sure that STEREO switch is set to ON.
7. Press RECORD button.
8. To stop recording, press STOP button.
9. To playback rewind tape and set the AUTO/LINEAR select switch to "AUTO", then press PLAY.

Note:

1. It is not required to turn the TV on.
2. Only audio is recorded and video is not recorded when no connection is made for the video in jack.

RECORDING FROM A VIDEO CAMERA

You will need a Video Camera and Power Supply for Video camera. At first you must connect the Video Camera to Power Supply and then connect Power Supply to VTR. (Refer to the Instruction Manual of the Camera as well as these instructions.)

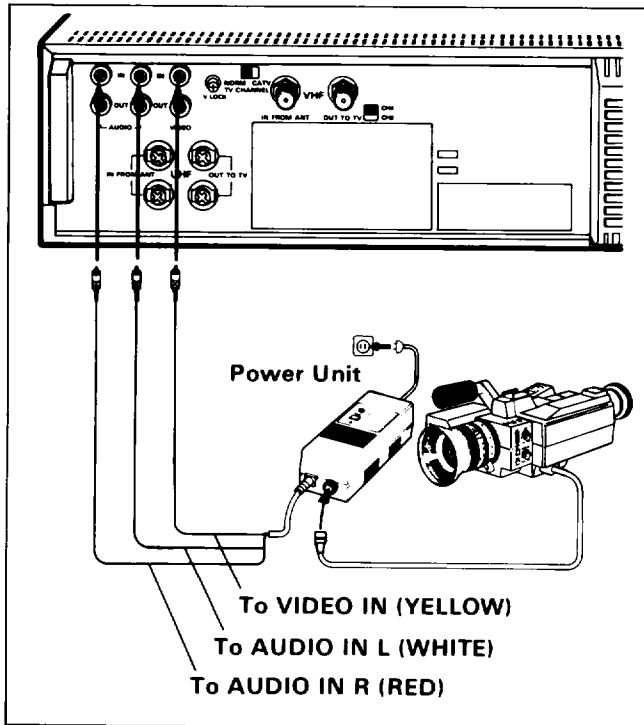

1. Turn on Power Unit.
2. Insert cassette.
VTR power is turned on automatically.
3. Set the SPEED select switch to "SP", "LP" or "EP".
4. Press the CHANNEL select button until the AUX indicator lights up on the display. If you have skipped the AUX position from the VTR tuner, restore it. See page 16 for details.
5. Make sure that the STEREO switch is set to ON.
6. Adjust focus and white balance on camera. (Refer to Instruction Manual of video camera.)
7. Press RECORD button.
8. Press STOP button to stop recording.

HEAD CLEANING

- Picture playback may become blurred or be interrupted while the TV program received is clear. This does not mean that the recorded program has been erased. (See figure below.)
- Dirt accumulated on the head after long periods of use causes this problem. In this case, head cleaning requiring highly technical care is necessary.
- Video heads rotate rapidly and are easily damaged if they contact objects other than video tape. Under most conditions, they tend to be self cleaning due to contact with the tape. If the video heads become dirty, the picture will become snowy. Only when the picture becomes snowy and the tracking control has no effect, should the heads be cleaned. Head Cleaning Cassettes are available in the marketplace for customer use, but the quality and effectiveness of these Cleaning Cassettes ranges from satisfactory to poor. Some cleaning cassettes increase head wear or cause damage to the video heads. Others may become stuck in the machine. We recommend that head cleaning be performed only by qualified video recorder technicians. Head cleaning or malfunctions caused by head cleaning is not covered by the Limited Warranty.



Example of playback with dirty video heads

PERIODIC MAINTENANCE

The VTR is a precision electromechanical device which will require periodic maintenance after a period of normal use. We expect that no maintenance other than head cleaning will be required during the warranty period by most users, unless the VTR is heavily used or seldom used. Normal maintenance is the responsibility of the user, although defective parts are covered during the warranty period. Consult your VTR Service Center to determine recommendations for normal maintenance based on your location, use patterns and machine age.

PROBLEM GUIDE

PROBLEM	THINGS TO CHECK	SOLUTION
No power	<ul style="list-style-type: none"> Is power cord connected? 	<ul style="list-style-type: none"> Connect power cord to AC outlet.
Timer recording is not possible.	<ul style="list-style-type: none"> Is the program timer set correctly? Is the POWER switch set to "OFF"? Is the record safety tab missing? 	<ul style="list-style-type: none"> Set the program timer correctly. Set the POWER switch to "OFF". Place cellophane tape over missing safety tab.
REC mode cannot be engaged.	<ul style="list-style-type: none"> Is the record safety tab missing? 	<ul style="list-style-type: none"> Place cellophane tape over missing safety tab.
Picture is poor on playback.	<ul style="list-style-type: none"> Is the TV channel selector on the proper channel? Is the TV fine tuning set correctly? 	<ul style="list-style-type: none"> On playback, the TV channel selector should be on channel 3 or 4. Fine tune your TV.
Noise in picture on playback	<ul style="list-style-type: none"> Are video heads clean? 	<ul style="list-style-type: none"> Head cleaning is necessary.
No picture on playback	<ul style="list-style-type: none"> Is the TV set to the proper channel? 	<ul style="list-style-type: none"> Set to correct channel, CH3 or 4. (for your video channel)
Playback picture is partially noisy.	<ul style="list-style-type: none"> Is the TRACKING control set to center position? 	<ul style="list-style-type: none"> Adjust TRACKING control for better picture.
TV program cannot be recorded or cannot be seen.	<ul style="list-style-type: none"> Is connection correct? 	<ul style="list-style-type: none"> Connect correctly.
Camera recording is not possible.	<ul style="list-style-type: none"> Is the AUX indicator on? 	<ul style="list-style-type: none"> Press CHANNEL select button until the AUX indicator lights up on the display.
Hi-Fi sound is not heard entirely or is interrupted.	<ul style="list-style-type: none"> Is the AUTO/LINEAR select switch set to "AUTO"? Is the tracking control set properly? Are the rotary heads (Hi-Fi audio heads) dirty? Only the NORMAL sound is played back when the tape is traced with dirty heads. Is the tape played back old or scratched? 	<ul style="list-style-type: none"> Set the switch to "AUTO". Turn the control gradually to adjust for optimum sound. Return it to the center position after playback is completed. It is necessary to clean the heads. Consult your nearest dealer or service center. Replace the tape. Record audio on a new tape and play it back.

SPECIFICATIONS

Recording:	Rotary two head Helical Scan Azimuth Recording
Video:	NTSC Color EIA Standard
Cassette:	VHS Type
Heads:	3 video heads: 2 for SP/LP/EP, 1 for special effect 2 Hi-Fi audio heads 1 Full track audio/video erase head 1 Combination head for control track, audio erase and 1 audio record/play (3 heads/single housing)
Tape Speed:	33.35 mm/sec (SP), 16.67 mm/sec (LP), 11.12 mm/sec (EP)
Tape Width:	12.7 mm
RF Output:	Channel 3 or Channel 4
RF Input:	VHF 75 ohm, UHF 300 ohm
Tuning Range:	VHF LOW, CH2 ~ 6 (54 MHz - 88 MHz) VHF HIGH, CH7 ~ 13 (174 MHz - 216 MHz) VHF MID. CH A-2, A-1 and A ~ 1 (108 MHz - 174 MHz) CATV VHF SUPER CH J ~ W (216 MHz - 300 MHz) CATV VHF HIPER CH W+1 ~ W+12 (300 MHz ~ 372 MHz) CATV UHF CH, 14 ~ 83 (470 MHz - 890 MHz)
Video Input:	1 - 2 Vp-p 75 ohm Unbalanced
Video Output:	1 Vp-p 75 ohm Unbalanced
Video Recording S/N:	Better than 46 dB (SP), Better than 43 dB (LP), Better than 40 dB (EP)
Horizontal Resolution:	240 lines (SP), 230 lines (LP), 230 lines (EP)
Audio	
Input:	Line: 316 mVrms (-7.8 dB) 50 kohm
Output:	Line: 316 mVrms (-7.8 dB) 1 kohm Headphone: 8 ohm 3.5 mmφ
S/N Ratio:	42 dB (SP)
Frequency Range:	100 Hz to 8 kHz (SP)
Hi-Fi Audio	
Frequency Range:	20 Hz to 20 kHz Dynamic Range: More than 80 dB
Wow and Flutter:	Less than 0.005% WRMS
Power Input:	AC 120V 60 Hz
Power Consumption:	39W Nominal
Cabinet Size:	17-1/8"(W) x 3-3/4"(H) x 13-7/16"(D) 43.5(W) x 9.5(H) x 34.2(D) cm
Weight:	17.6 lbs (8.0 kg)
Accessories:	1 - Coaxial cable w/adaptor 1 - 300-ohm flat lead twin cable 1 - VHF antenna adaptor 1 - Remote control unit 2 - Batteries

Design and Specifications subject to change without notice.

PENTAX

PENTAX CORPORATION. 35 Inverness Drive East Englewood, CO 80112
Service information : (303) 799-8000

PENTAX CORPORATION. 1101 Stewart Ave. Garden City, NY 11530
Service information : (516) 222-0830

PENTAX CORPORATION. 350 East Devon Ave. Itasca, IL 60143
Service information : (312) 250-9000

PENTAX CORPORATION. 8363 Reseda Blvd. Northridge, CA 91324
Service information : (818) 701-5080